

16-/24-Port 10/100/1000T 802.3bt PoE++ plus 4-Port Gigabit TP/SFP Combo Managed Switch

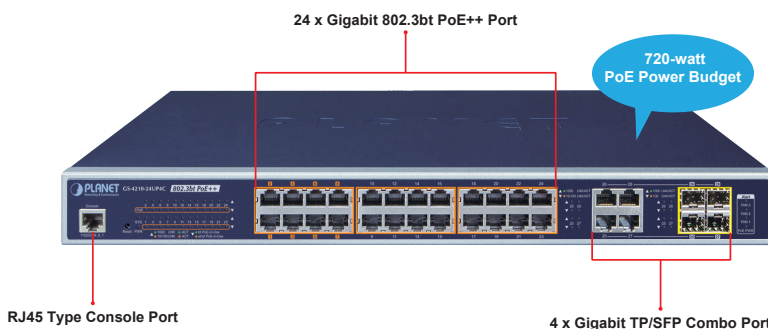

Perfect Managed PoE++ Switches with Advanced L2/L4 Switching and Security

PLANET GS-4210-16UP4C and GS-4210-24UP4C are cost-optimized, Gigabit 802.3bt PoE++ Managed Switches featuring PLANET **intelligent PoE** functions to improve the availability of critical business applications. They provide IPv6/IPv4 dual stack management and built-in L2/L4 Gigabit switching engine along with **16/24 10/100/1000BASE-T** ports featuring **95-watt 802.3bt type-4 PoE++ injector ports** and **4 additional Gigabit TP/SFP combo ports**. With a total power budget of up to **400W and 720 watts** for different kinds of PoE applications, the GS-4210-16UP4C and GS-4210-24UP4C provide a quick, safe and cost-effective 802.3bt PoE++ network solution for small businesses and enterprises.

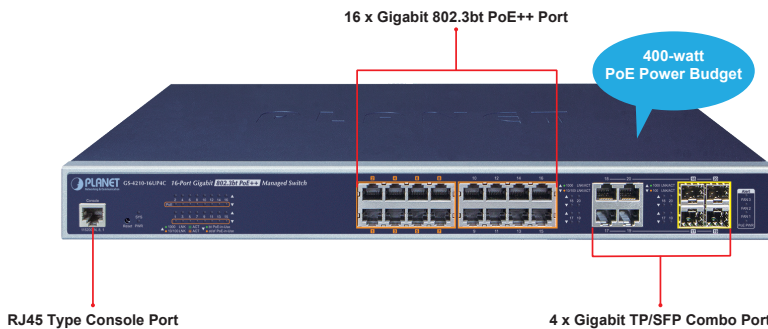

GS-4210-16UP4C Physical Port

- 20 10/100/1000BASE-T RJ45 copper ports with 16-Port IEEE 802.3af PoE/802.3at PoE+/802.3bt PoE++ injector
- 4 100/1000BASE-X SFP slots, shared with ports 17 to 20 compatible with 100BASE-FX SFP
- RJ45 console interface for switch basic management and setup

GS-4210-24UP4C Physical Port

- 28 10/100/1000BASE-T RJ45 copper ports with 24-Port IEEE 802.3af PoE/802.3at PoE+/802.3bt PoE++ injector
- 4 100/1000BASE-X SFP slots, shared with ports 25 to 28 compatible with 100BASE-FX SFP
- RJ45 console interface for switch basic management and setup

Switching

- Hardware-based 10/100Mbps, half/full duplex and 1000Mbps full duplex mode, flow control and auto-negotiation, and auto MDI/MDI-X
- Features Store-and-Forward mode with wire-speed filtering and forwarding rates
- IEEE 802.3x flow control for full duplex operation and back pressure for half duplex operation
- 10K jumbo frame
- Automatic address learning and address aging
- Supports CSMA/CD protocol

Power over Ethernet

- Complies with IEEE 802.3bt Power over Ethernet Plus Plus
- Backward compatible with IEEE 802.3at Power over Ethernet Plus
- Up to 16/24 ports of IEEE 802.3at/IEEE 802.3bt PoE devices powered
- 16/24 PoE ports with built-in 802.3bt type-4 PoE 95W injector function
- All PoE ports support 802.3at end-span/mid-span PoE 36W injector function
- Auto detects powered device (PD)
- Circuit protection prevents power interference between ports
- Remote power feeding up to 100 meters in standard mode and 250m in extend mode



Cybersecurity Network Solution to Minimize Security Risks

The cybersecurity feature included to protect the switch management in a mission-critical network virtually needs no effort and cost to install. Both SSHv2 and TLSv1.2 protocols are utilized to provide strong protection against advanced threats. The network administrator can now construct highly-secure corporate networks with considerably less time and effort than before.



Redundant Ring, Fast Recovery for Critical Network Applications

The GS-4210-16UP4C and GS-4210-24UP4C support redundant ring technology and features strong, rapid self-recovery capability to prevent interruptions and external intrusions. They incorporate advanced ITU-T G.8032 ERPS (Ethernet Ring Protection Switching) technology, Spanning Tree Protocol (802.1s MSTP) into customer's network to enhance system reliability and uptime in various environments.

ERPS Ring for Video Transmission Redundancy

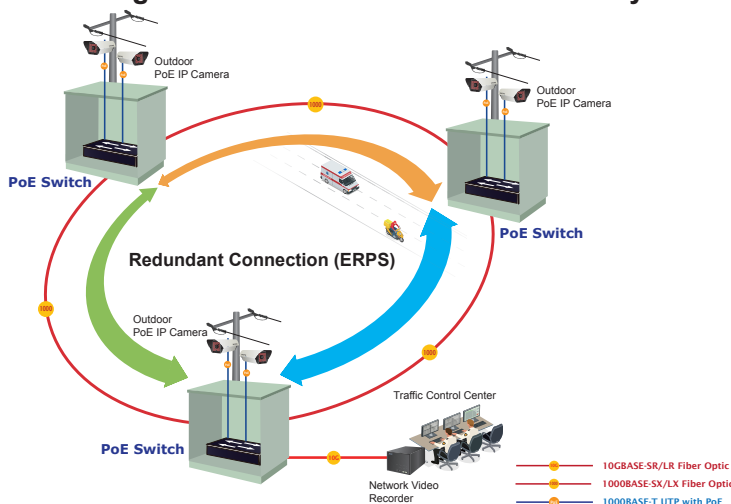

- PoE management
 - PoE admin-mode control
 - PoE Consumption and allocation mode option
 - Temperature threshold control
 - PoE Budget 720W/660W/600W(Factory default) mode option (GS-4210-24UP4C only)
 - Per port PoE function enable/disable
 - Per port PoE Inline mode option (802.3BT(Factory default)/End-span/Mid-span)
 - Per port PD type option (Standard(Factory default)/Legacy/Force)
 - PoE port power feeding priority
 - PD classification detection
- Intelligent PoE features
 - PoE extension
 - PoE schedule
 - PD alive check

Layer 2 Features

- Prevents packet loss with back pressure (half-duplex) and IEEE 802.3x pause frame flow control (full-duplex)
- High performance Store and Forward architecture, broadcast storm control, and runt/CRC filtering that eliminates erroneous packets to optimize the network bandwidth
- Supports **VLAN**
 - IEEE 802.1Q tagged VLAN
 - Provider Bridging (VLAN Q-in-Q) support (IEEE 802.1ad)
 - Protocol VLAN
 - Voice VLAN
 - Private VLAN
 - Management VLAN
 - GVRP
- Supports **Spanning Tree Protocol**
 - STP (Spanning Tree Protocol)
 - RSTP (Rapid Spanning Tree Protocol)
 - MSTP (Multiple Spanning Tree Protocol)
 - STP BPDU Guard, BPDU filtering and BPDU forwarding
- Supports **Link Aggregation**
 - IEEE 802.3ad Link Aggregation Control Protocol (LACP)
 - Cisco ether-channel (static trunk)
- Provides port mirror (many-to-1)
- Loop protection to avoid broadcast loops
- Supports ERPS (Ethernet Ring Protection Switching)

Quality of Service

- Ingress and egress rate limit per port bandwidth control
- Storm control support
 - Broadcast/Unknown unicast/Unknown multicast
- Traffic classification
 - IEEE 802.1p CoS
 - TOS/DSCP/IP precedence of IPv4/IPv6 packets

802.3bt PoE++ 95-watt Power over 4-pair UTP Solution

As the GS-4210-16UP4C and GS-4210-24UP4C adopt the IEEE 802.3bt PoE++ standard technology, they are capable to source up to **95 watts** of power by using all the four pairs of standard Cat5e/6 Ethernet cabling to deliver power and full-speed data to each remote PoE compliant powered device (PD). Their power capability is three times more than that of the conventional 802.3at PoE+ and they are an ideal solution for those high power consuming network PDs, such as:

- PoE PTZ speed dome cameras
- Network devices
- Thin clients
- AIO (all-in-one) touch PCs, point of sale (POS) and information kiosks
- Remote digital signage displays
- PoE lightings

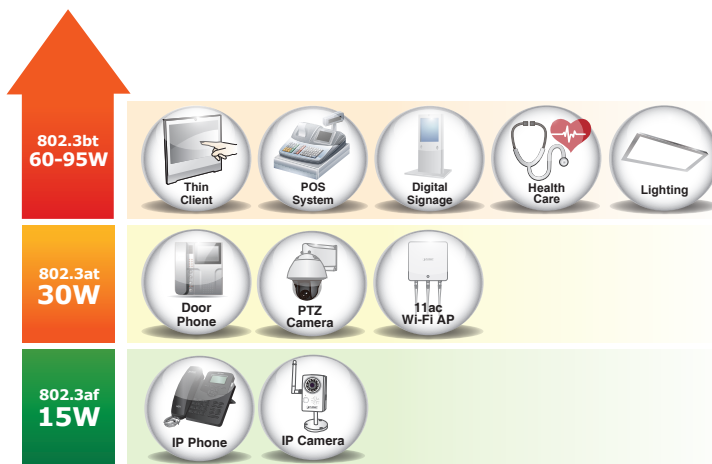

802.3bt PoE++ and Advanced PoE Power Output Mode Management

To meet the demand of various powered devices consuming stable PoE power, the GS-4210-16UP4C and GS-4210-24UP4C support multi-PoE operation modes that include 95-watt 802.3bt type-4 PoE++ mode, 4-pair legacy and force mode to solve the incompatibility of non-standard 4-pair PoE PDs in the field.

- **95W 802.3bt PoE++ Power Output Mode**
- **36W End-span 802.3at PoE+ Power Output Mode**
- **36W Mid-span 802.3at PoE+ Power Output Mode**

PoE Watts	PoE Operation Mode	Power Output Mode
95W	802.3bt PoE++	(Pins 1, 2, 3, 6 + Pins 4, 5, 7, 8)
36W	End-span 802.3at PoE	(Pins 1, 2, 3, 6)
36W	Mid-span 802.3at PoE	(Pins 4, 5, 7, 8)

Built-in Unique PoE Functions for Powered Devices Management

As GS-4210-16UP4C and GS-4210-24UP4C are the managed PoE++ switches for surveillance, wireless and VoIP networks, they feature the following special PoE management functions:

- PD Alive Check
- Scheduled Power Recycling
- PoE Schedule
- PoE Usage Monitoring
- PoE Extension

- Strict priority and Weighted Round Robin (WRR) CoS policies

Multicast

- Supports IPv4 IGMP snooping v2 and v3
- Supports IPv6 MLD snooping v1, v2
- IGMP querier mode support
- IGMP snooping port filtering
- MLD snooping port filtering

Security

- Authentication
 - IEEE 802.1X port-based network access authentication
 - Built-in RADIUS client to cooperate with the RADIUS servers
 - RADIUS/TACACS+ login user access authentication
- Access control list
 - IPv4/IPv6 IP-based ACL
 - MAC-based ACL
- MAC security
 - Static MAC
 - MAC filtering
- Port security for source MAC address entries filtering
- DHCP snooping to filter distrusted DHCP messages
- Dynamic ARP Inspection discards ARP packets with invalid MAC address to IP address binding
- IP source guard prevents IP spoofing attacks
- DoS attack prevention
- IP address access management to prevent unauthorized intruder

Management

- IPv4 and IPv6 dual stack management
- Switch management interface
 - Web switch management
 - Console and telnet command line interface
 - SNMP v1 and v2c switch management
 - SSHv2, TLSv1.2 and SNMP v3 secure access
- SNMP Management
 - Four RMON groups (history, statistics, alarms and events)
 - SNMP trap for interface link up and link down notification
- User privilege levels control
- Built-in Trivial File Transfer Protocol (TFTP) client
- BOOTP and DHCP for IP address assignment
- System maintenance
 - Firmware upload/download via HTTP/TFTP
 - Configuration upload/download through web interface
 - Dual images
 - Hardware reset button for system reboot or reset to factory default

Intelligent Powered Device Alive Check

The GS-4210-16UP4C and GS-4210-24UP4C can be configured to monitor connected PD status in real time via ping action. Once the PD stops working and responding, the GS-4210-16UP4C and GS-4210-24UP4C will resume the PoE port power and bring the PD back to work. They will greatly enhance the network reliability through the PoE port resetting the PD's power source and reducing administrator management burden.

PD Alive Check

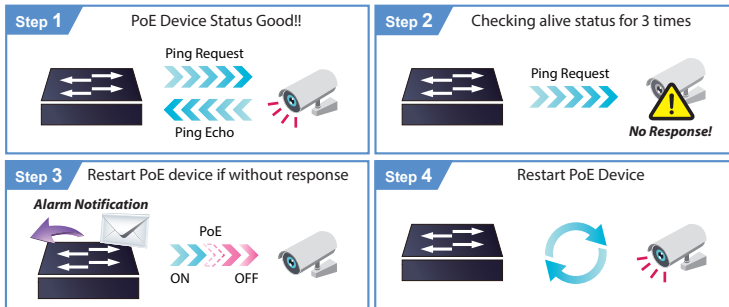

- SNTP Network Time Protocol
- Network Diagnostic
 - SFP-DDM (digital diagnostic monitor)
 - Cable diagnostics
 - ICMPv4/ICMPv6 remote ping
- Link Layer Discovery Protocol (LLDP) and LLDP-MED
- Event message logging to remote syslog server
- Smart fan with speed control
- PLANET Smart Discovery Utility for deployment management
- PLANET NMS system and CloudViewer for deployment management

Scheduled Power Recycling

The GS-4210-16UP4C and GS-4210-24UP4C allow each of the connected PoE IP cameras or PoE wireless access points to reboot at a specified time each week. Therefore, it will reduce the chance of IP camera or AP crash resulting from buffer overflow.

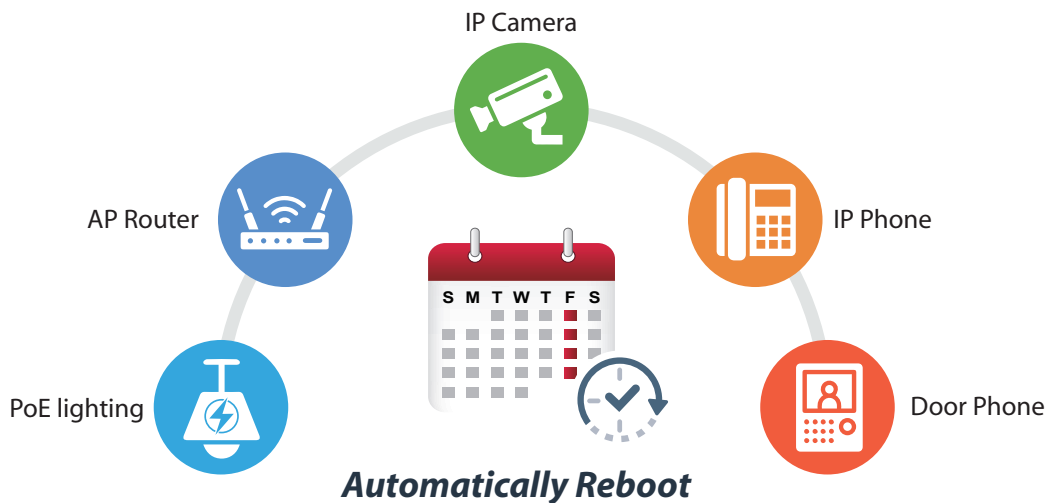

PoE Schedule for Energy Savings

Under the trend of energy saving worldwide and contributing to environmental protection, the GS-4210-16UP4C and GS-4210-24UP4C can effectively control the power supply besides its capability of giving high watts power. The “PoE schedule” function helps you to enable or disable PoE power feeding for each PoE port during specified time intervals and it is a powerful function to help SMBs or Enterprises save power and money. It also increases security by powering off PDs that should not be in use during non-business hours.

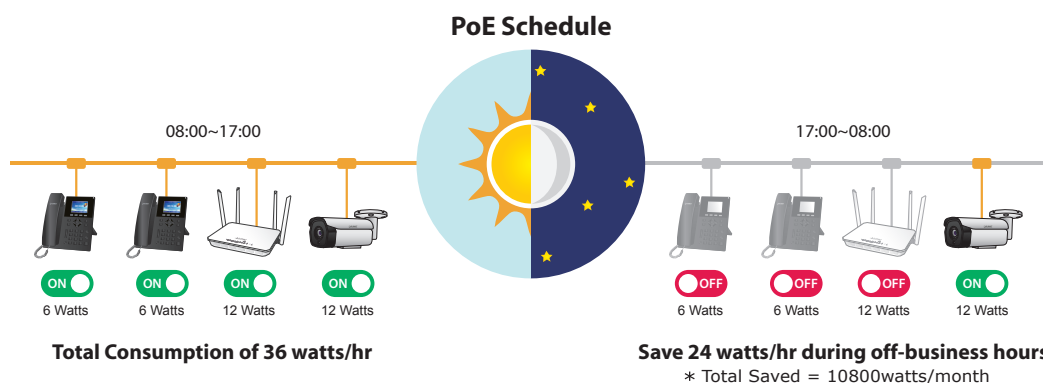

PoE Usage Monitoring

Via the power usage chart in the web management interface, the GS-4210-16UP4C and GS-4210-24UP4C enable the administrator to monitor the status of the power usage of the connected PDs in real time. Thus, they greatly enhance the management efficiency of the facilities.

802.3at PoE+ Power and Ethernet Data Transmission Distance Extension

In the "Extend" operation mode, the GS-4210-16UP4C and GS-4210-24UP4C operate on a per-port basis at 10Mbps duplex operation but can support 50-watt PoE power output over a distance of up to 250 meters overcoming the 100m limit on Ethernet UTP cable. With this brand-new feature, the GS-4210-16UP4C and GS-4210-24UP4C provide an additional solution for 802.3at/af PoE distance extension, thus saving the cost of Ethernet cable installation.

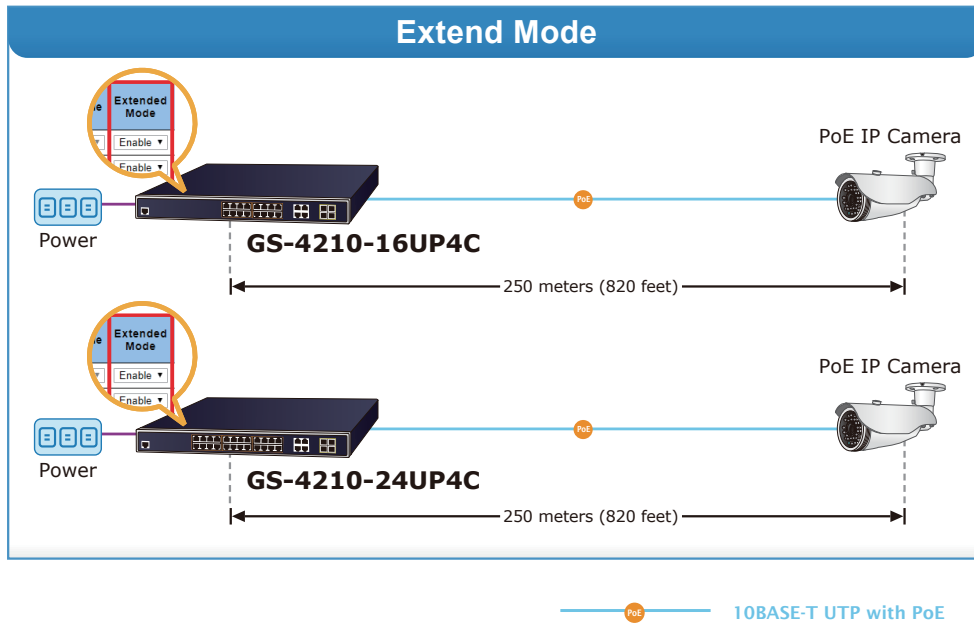

Environment-friendly, Smart Fan Design for Silent Operation

The GS-4210-16UP4C and GS-4210-24UP4C feature a desktop-sized metal housing, a low noise design and an effective ventilation system. They support the smart fan technology that automatically controls the speed of the built-in fan to reduce noise and maintain the temperature of the PoE switch for optimal power output capability. The GS-4210-16UP4C and GS-4210-24UP4C are able to operate reliably, stably and quietly in any environment without affecting its performance.

IPv6/IPv4 Dual Stack Management

Supporting both IPv6 and IPv4 protocols, the GS-4210-16UP4C and GS-4210-24UP4C help the SMBs to step in the IPv6 era with the lowest investment as their network facilities need not be replaced or overhauled if the IPv6 FTTx edge network is set up.

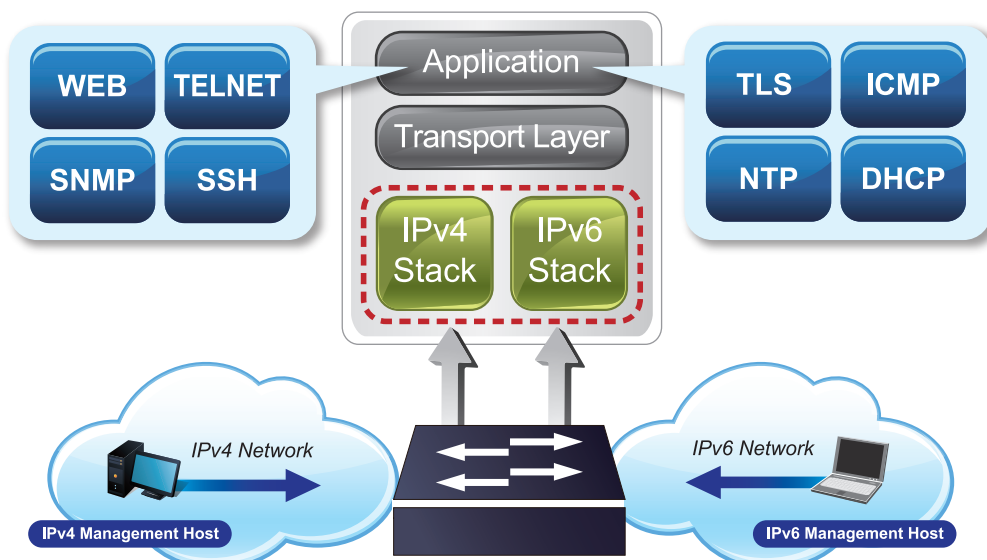

Robust Layer 2 Features

The GS-4210-16UP4C and GS-4210-24UP4C can be programmed for advanced switch management functions such as dynamic port link aggregation, 802.1Q VLAN and **Q-in-Q VLAN**, **Multiple Spanning Tree Protocol (MSTP)**, loop and **BPD guard**, **IGMP snooping**, and **MLD snooping**. Via the link aggregation, the GS-4210-16UP4C and GS-4210-24UP4C allows the operation of a high-speed trunk to combine with multiple ports, and supports fail-over as well. Also, the **Link Layer Discovery Protocol (LLDP)** is the Layer 2 protocol included to help discover basic information about neighboring devices on the local broadcast domain.

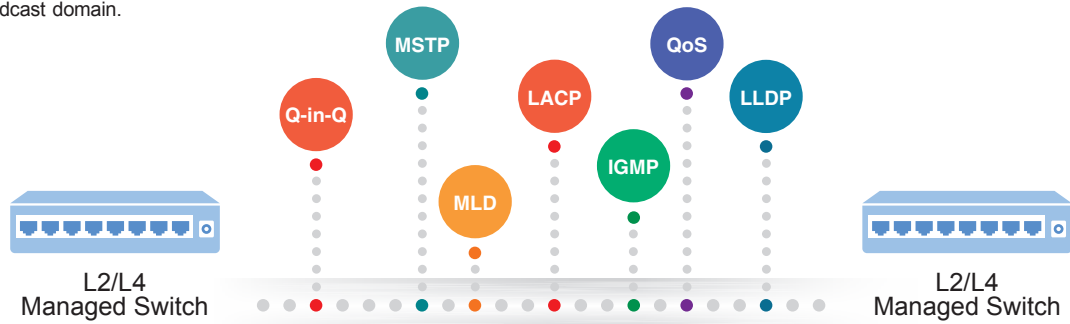

Efficient Traffic Control

The GS-4210-16UP4C and GS-4210-24UP4C are loaded with robust QoS features and powerful traffic management to enhance services to business-class data, voice and video solutions. The functionality includes broadcast/multicast **storm control**, per port **bandwidth control**, IP DSCP QoS priority and remarking. It guarantees the best performance for VoIP and video stream transmission, and empowers the enterprises to take full advantage of the limited network resources.

Powerful Security

The GS-4210-16UP4C and GS-4210-24UP4C offers comprehensive Layer 2 to Layer 4 Access Control List (ACL) for enforcing security to the edge. It can be used to restrict network access by denying packets based on source and destination IP address, TCP/UDP ports or defined typical network applications. Its protection mechanism also comprises 802.1x Port-based user authentication. With the private VLAN function, communication between edge ports can be prevented to ensure user privacy.

Advanced IP Network Protection

The GS-4210-16UP4C and GS-4210-24UP4C also provide **DHCP Snooping**, **IP Source Guard** and **Dynamic ARP Inspection** functions to prevent IP snooping from attack and discard ARP packets with invalid MAC address. The network administrator can now build highly-secure corporate networks with considerably less time and effort than before.

Efficient Management

For efficient management, the GS-4210-16UP4C and GS-4210-24UP4C are equipped with Command line, Web and SNMP management interfaces.

- With the built-in **Web-based** management interface, the GS-4210-16UP4C and GS-4210-24UP4C offer an easy-to-use, platform-independent management and configuration facility.
- For **text-based** management, it can be accessed via Telnet and the console port.
- By supporting the standard SNMP protocol, the switches can be managed via any SNMP-based management software.

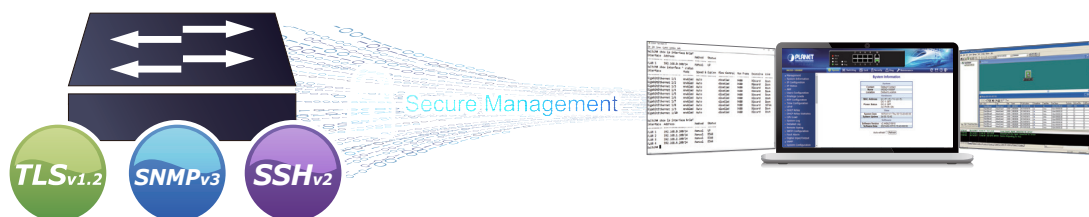

Remote Management Solution

PLANET's **Universal Network Management System (UNI-NMS)** and CloudViewer app support IT staff by remotely managing all network devices and monitoring PDs' operational statuses. Thus, they're designed for both the enterprises and industries where deployments of PDs can be as remote as possible, without having to go to the actual location once a bug or faulty condition is found. With the UNI-NMS or CloudViewer app, all kinds of businesses can now be speedily and efficiently managed from one platform.



Flexibility and Long-distance Extension Solution

The GS-4210-16UP4C and GS-4210-24UP4C provide 4 extra Gigabit TP interfaces supporting 10/100/1000BASE-T RJ45 copper to connect with surveillance network devices such as NVR, Video Streaming Server or NAS to facilitate surveillance management. Or through these **dual-speed fiber SFP slots**, they feature **100BASE-FX** and **1000BASE-SX/LX SFP** (Small Form-factor Pluggable) fiber transceivers to uplink to backbone switch and monitoring center in long distance. The distance can be extended from 550 meters to 2 kilometers (multi-mode fiber) and to 10/20/40/60/80/120 kilometers (single-mode fiber or WDM fiber). They are well suited for applications within the enterprise data centers and distributions.

Intelligent SFP Diagnosis Mechanism

The GS-4210-16UP4C and GS-4210-24UP4C support **SFP-DDM (Digital Diagnostic Monitor)** function that can easily monitor real-time parameters of the SFP for network administrator, such as optical output power, optical input power, temperature, laser bias current and transceiver supply voltage.

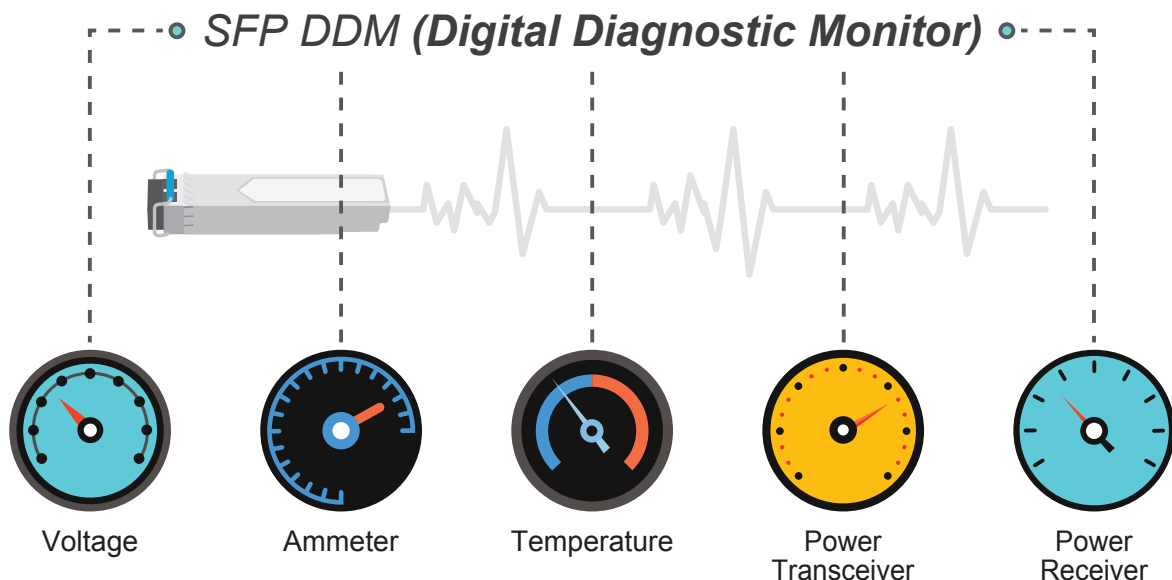

Applications

ITU-T G.8032 ERPS with PoE IP Surveillance System for SMBs/Workgroups

The GS-4210-16UP4C and GS-4210-24UP4C feature strong rapid self-recovery capability to prevent interruptions and external intrusions. They incorporate **ITU-T G.8032 ERPS (Ethernet Ring Protection Switching)** technology into customer's automation network to enhance system reliability and uptime. Applying the IEEE 802.3at Power over Ethernet standard, the GS-4210-16UP4C and GS-4210-24UP4C can directly connect with any IEEE 802.3at end nodes like PTZ (pan, tilt, zoom) network cameras and speed dome cameras. The GS-4210-16UP4C and GS-4210-24UP4C can easily build a power that can centrally control a wireless AP, IP camera and VoIP system for SMBs and workgroups in the enterprises with high availability network infrastructure.

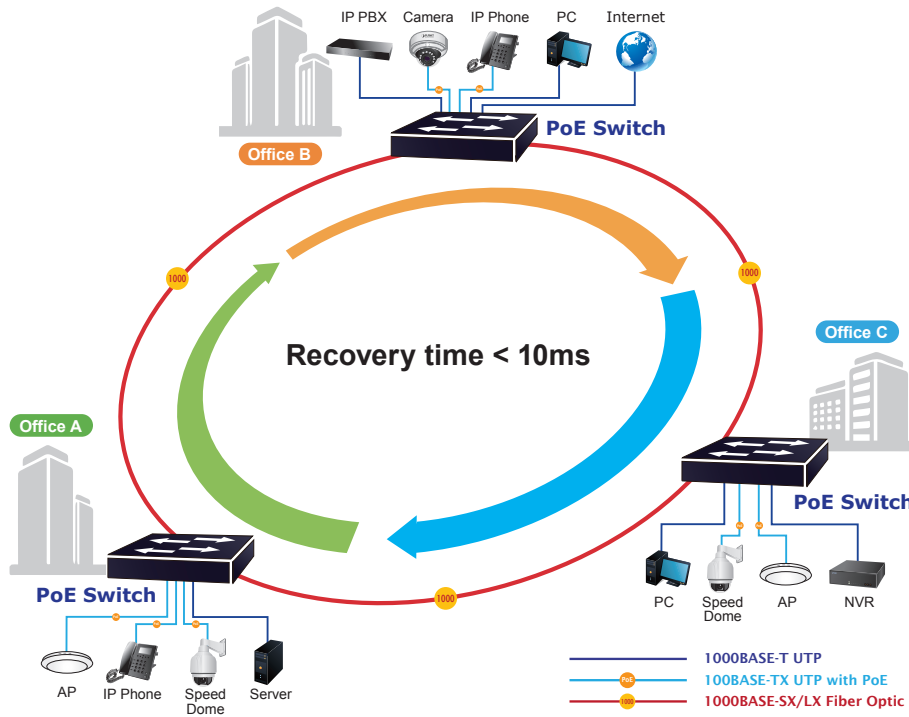

Gigabit 802.3bt PoE++ and PoE+ Network Deployment Solution

PLANET GS-4210-16UP4C and GS-4210-24UP4C can easily build an 802.3BT PoE++ networking solution on the cyber security system for the enterprises. For instance, They can work with the POS system and thin client to perform comprehensive security protection for today's businesses. The GS-4210-16UP4C or GS-4210-24UP4C and 802.3bt PoE++ Splitter-POE-173S operate as a pair to provide the easiest way to power your Ethernet devices which need high power input. Receiving data and power from the GS-4210-16UP4C and GS-4210-24UP4C, the POE-173S separates digital data and power into three optional outputs (12V, 19V or 24V DC) to non-PoE devices such as laptops, Thin Client, POS System, PTZ (pan, tilt & zoom) network cameras, PTZ speed dome, color touch-screen IP phones, multi-channel wireless LAN access points and other network devices at distance up to 100 meters.

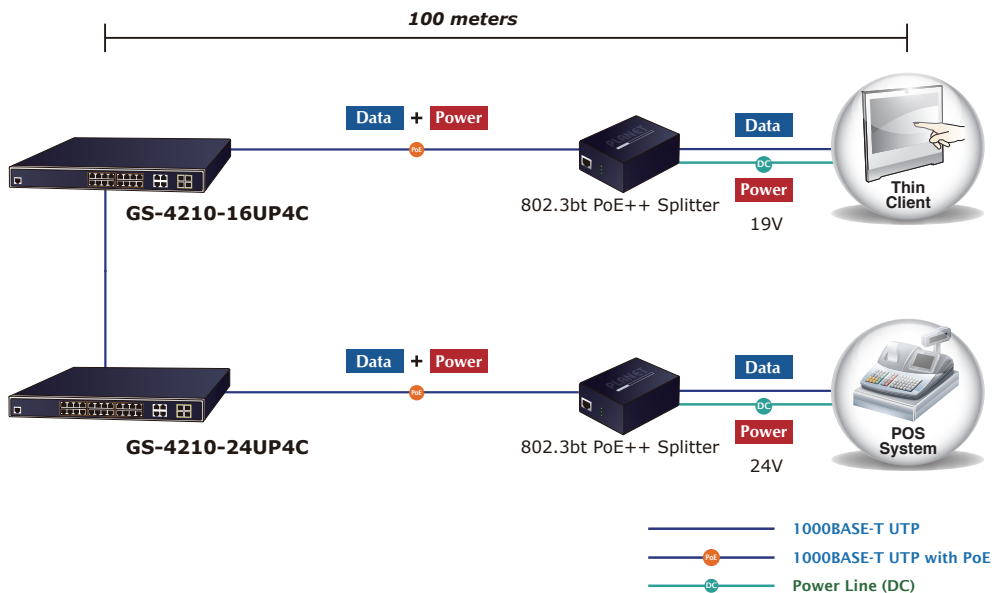

Specifications

Product	GS-4210-16UP4C	GS-4210-24UP4C
Hardware Specifications		
RJ45 Copper Ports (MDI/MDIX)	20 x 10/100/1000BASE-T RJ45	28 x 10/100/1000BASE-T RJ45
PoE Injector Port	16 ports with 802.3at/af/802.3bt PoE++ injector function (Ports 1 to 16)	24 ports with 802.3at/af/802.3bt PoE++ injector function (Ports 1 to 24)
SFP/mini-GBIC Port	4 100/1000BASE-X SFP interfaces (Ports 17 to 20) Supports 100/1000Mbps dual mode and DDM	4 100/1000BASE-X SFP interfaces (Ports 25 to 28) Supports 100/1000Mbps dual mode and DDM
Console	1 x RS-232-to-RJ45 serial port (115200, 8, N, 1)	
Reset Button	< 5 sec: System reboot > 5 sec: Factory default	
Fan	3 x smart fan	
Dimensions (W x D x H)	440 x 300 x 44.5 mm, 1U height	
Weight	4.4kg	5kg
Enclosure	Metal	
Power Requirements	100~240V AC, 50/60Hz, auto-sensing	
Power Consumption/Dissipation	520 watts (max.)/1774BTU	900 watts (max.)/3070 BTU
LED	<p>System: PWR x1 (Green) SYS x1 (Green)</p> <p>Per PoE Port (Ports 1 to 16/24): 10/100/1000 LNK/ACT x1 (10/100:Amber.1000:Green) IEEE 802.3af/at/bt PoE-in-use x1 (802.3af/at: Amber. 802.3bt: Green)</p> <p>Per Gigabit TP Port (Ports 17/25 to 20/28): 10/100 LNK/ACT x1 (Amber) 1000 LNK/ACT x1 (Green)</p> <p>Per Gigabit SFP Port (Ports 17/25 to 20/28): 100 LNK/ACT x1 (Amber) 1000 LNK/ACT x1 (Green)</p> <p>Alert: PoE PWR x1 (Red) Fan 1 x1 (Red) Fan 2 x1 (Red) Fan 3 x1 (Red)</p>	
Switch Specifications		
Switch Architecture	Store-and-Forward	
Switch Fabric	40Gbps/non-blocking	56Gbps/non-blocking
Switch Throughput@64Bytes	29.7Mpps	41.67Mpps
Address Table	8K entries	
Shared Data Buffer	4.1 megabits	
Flow Control	IEEE 802.3x pause frame for full duplex Back pressure for half duplex	
Jumbo Frame	10K bytes	
Power over Ethernet		
PoE Standard	IEEE 802.3bt PoE++ PSE Backward compatible with IEEE 802.3at/af PoE PSE	
PoE Power Supply Type	<ul style="list-style-type: none"> ■ 802.3BT ■ End-span ■ Mid-span 	
PoE Power Output	Per port 54V DC <ul style="list-style-type: none"> ■ 802.3bt mode, Ports 1 to 16/24: maximum 95 watts ■ End-span mode: maximum 36 watts ■ Mid-span mode: maximum 36 watts 	
Power Pin Assignment	<ul style="list-style-type: none"> ■ 802.3bt: 1/2(-), 3/6(+), 4/5(+), 7/8(-) ■ End-span: 1/2(-), 3/6(+) ■ Mid-span: 4/5(+), 7/8(-) 	
PoE Power Budget	400 watts (max)	720 watts, operating temperature < 40 degrees C 660 watts, operating temperature between 40 and 49 degrees C 600 watts, operating temperature around 50 degrees C (Factory default mode)
Number of 95W 802.3bt Type-4 PDs	4	7
Number of 60W 802.3bt Type-3 PDs	6	12

Number of 802.3at PDs	16	24
PoE Management Functions		
Enhanced PoE Mode	Standard/Legacy/Force	
Active PoE Device Detection	Yes	
PoE Power Recycling	Yes, daily or predefined schedule	
PoE Schedule	4 schedule profiles	
PoE Extend Mode	Yes, max. up to 250 meters	
PoE Port Management	<ul style="list-style-type: none"> ■ Port Enable/Disable/Schedule ■ PoE mode control <ul style="list-style-type: none"> - 802.3BT - 802.3at End-span - 802.3at Mid-span ■ Port Priority 	
Layer 2 Functions		
Port Mirroring	TX/RX/both Many-to-1 monitor Up to 4 sessions	
VLAN	802.1Q tagged VLAN Up to 256 VLAN groups, out of 4094 VLAN IDs 802.1ad Q-in-Q tunneling Voice VLAN Protocol VLAN Private VLAN (Protected port) GVRP	
Link Aggregation	IEEE 802.3ad LACP and static trunk	
Spanning Tree Protocol	IEEE 802.1D Spanning Tree Protocol (STP) IEEE 802.1w Rapid Spanning Tree Protocol (RSTP) IEEE 802.1s Multiple Spanning Tree Protocol (MSTP) STP BPDU Guard, BPDU Filtering and BPDU Forwarding	
IGMP Snooping	IPv4 IGMP (v2/v3) snooping IGMP querier Up to 256 multicast groups	
MLD Snooping	IPv6 MLD (v1/v2) snooping Up to 256 multicast groups	
QoS	8 mapping IDs to 8 level priority queues <ul style="list-style-type: none"> - Port number - 802.1p priority - DSCP/IP precedence of IPv4/IPv6 packets Traffic classification based, strict priority and WRR Ingress/Egress Rate Limit per port bandwidth control	
Ring	Supports ERPS, and complies with ITU-T G.8032 Recovery time < 450ms	
Security Functions		
Access Control List	IPv4/IPv6 IP-based ACL/MAC-based ACL IPv4/IPv6 IP-based ACE/MAC-based ACE Max. 256 ACL entries	
Port Security	IEEE 802.1X – Port-based authentication Built-in RADIUS client to co-operate with RADIUS server RADIUS/TACACS+ user access authentication	
MAC Security	IP-MAC port binding MAC filter Static MAC address, max. 256 static MAC entries	
Enhanced Security	DHCP Snooping and DHCP Option82 STP BPDU guard, BPDU filtering and BPDU forwarding DoS attack prevention ARP inspection IP source guard	
Management Functions		
Basic Management Interfaces	RS232 to RJ45 Console Web browser Telnet SNMP v1, v2c	
Secure Management Interfaces	SSHv2, TLS v1.2, SNMP v3	

System Management	Firmware upgrade by HTTP/TFTP protocol through Ethernet network LLDP protocol SNTP PLANET Smart Discovery Utility PLANET NMS System/CloudViewer
Event Management	Remote/Local Syslog System log
SNMP MIBs	RFC 1213 MIB-II RFC 1215 Generic Traps RFC 1493 Bridge MIB RFC 2674 Bridge MIB Extensions RFC 2737 Entity MIB (v2) RFC 2819 RMON (1, 2, 3, 9) RFC 2863 Interface Group MIB RFC 3635 Ethernet-like MIB RFC 3621 Power Ethernet MIB LLDP MIB
Standards Conformance	
Regulatory Compliance	FCC Part 15 Class A, CE
Standards Compliance	IEEE 802.3 10BASE-T IEEE 802.3u 100BASE-TX/100BASE-FX IEEE 802.3z Gigabit SX/LX IEEE 802.3ab Gigabit 1000T IEEE 802.3x flow control and back pressure IEEE 802.3ad port trunk with LACP IEEE 802.1D Spanning Tree protocol IEEE 802.1w Rapid Spanning Tree protocol IEEE 802.1s Multiple Spanning Tree protocol IEEE 802.1p Class of Service IEEE 802.1Q VLAN tagging IEEE 802.1x Port Authentication Network Control IEEE 802.1ab LLDP IEEE 802.3af Power over Ethernet IEEE 802.3at Power over Ethernet Plus IEEE 802.3bt Power over Ethernet Plus Plus IEEE 802.3az Energy Efficient Ethernet (EEE) RFC 768 UDP RFC 783 TFTP RFC 793 TCP RFC 791 IP RFC 792 ICMP RFC 2068 HTTP RFC 1112 IGMP version 1 RFC 2236 IGMP version 2 RFC 3376 IGMP version 3 RFC 2710 MLD version 1 RFC 3810 MLD version 2 ITU G.8032 ERPS Ring
Environment	
Operating	Temperature: 0 ~ 50 degrees C Relative Humidity: 5 ~ 95% (non-condensing)
Storage	Temperature: -10 ~ 70 degrees C Relative Humidity: 5 ~ 95% (non-condensing)

Dimensions

■ GS-4210-16UP4C

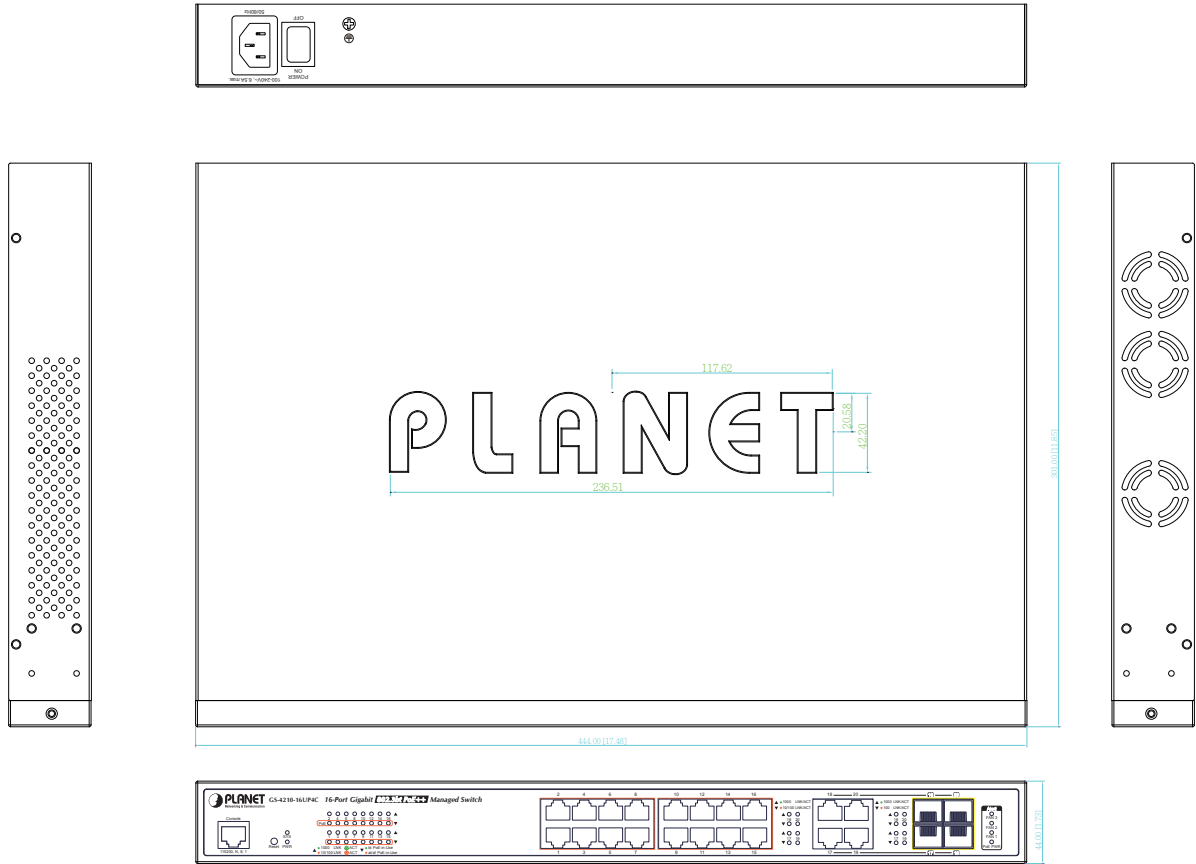

Unit: mm

■ GS-4210-24UP4C

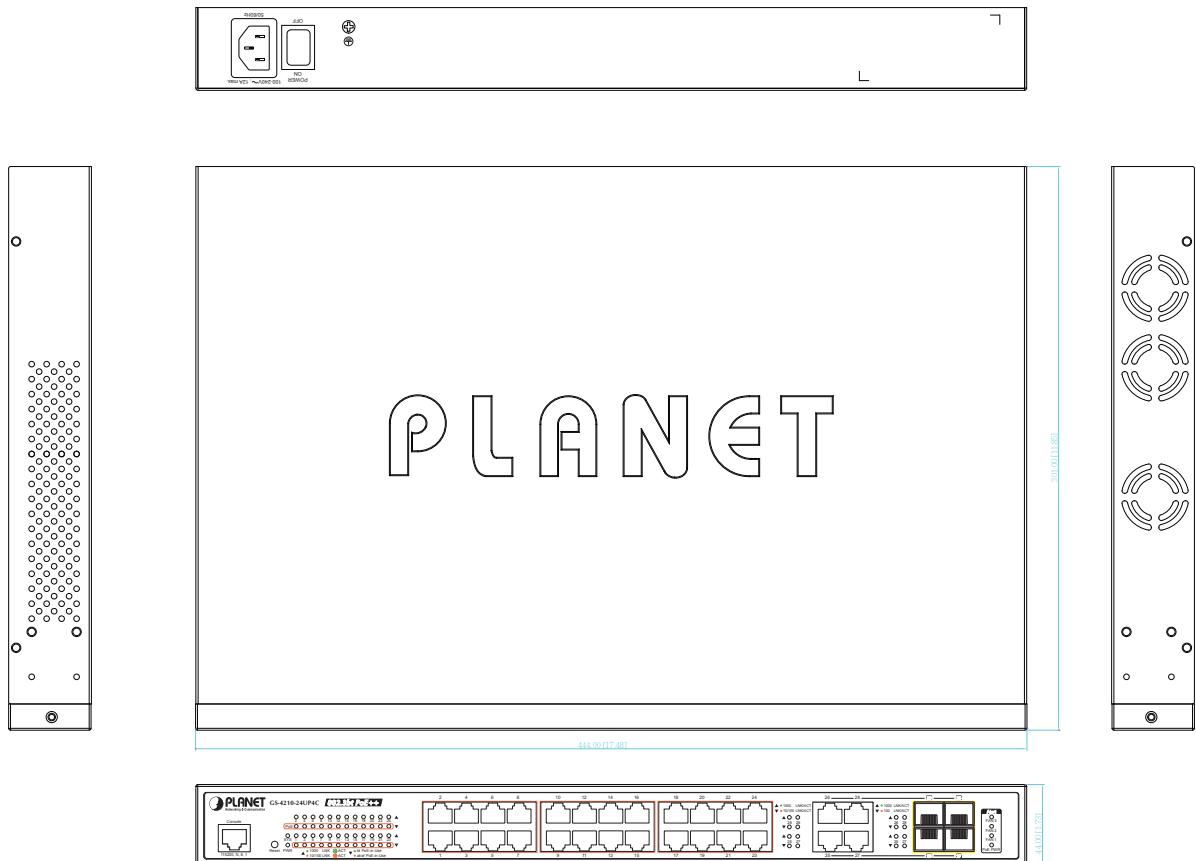

Unit: mm

Ordering Information

GS-4210-16UP4C	16-Port 10/100/1000T 802.3bt PoE++ plus 4-Port Gigabit TP/SFP Combo Managed Switch
GS-4210-24UP4C	24-Port 10/100/1000T 802.3bt PoE++ plus 4-Port Gigabit TP/SFP Combo Managed Switch

Related Products

GS-4210-24HP2C	4-Port 10/100/1000T 802.3bt PoE + 20-Port 10/100/1000T 802.3at PoE + 2-Port Gigabit TP/SFP Combo Managed Switch
GS-4210-8HP2S	2-Port 10/100/1000T 802.3bt PoE + 6-Port 10/100/1000T 802.3at PoE + 2-Port 100/1000X SFP Managed Switch
POE-E304	1-Port 802.3bt PoE++ to 4-Port 802.3af/at Gigabit PoE Extender
POE-173S	Single-Port 10/100/1000Mbps 802.3bt PoE++ Splitter
POE-171S	Single-Port 10/100/1000Mbps Ultra PoE Splitter (12V/19V/24V)
POE-172S	Single-Port 10/100/1000Mbps Ultra PoE Splitter (12V/19V/24V)

Available 100Mbps Modules

Fast Ethernet Transceiver (100BASE-X SFP)

Model	Speed (Mbps)	Connector Interface	Fiber Mode	Distance	Wavelength (nm)	Operating Temp.
MFB-FX	100	LC	Multi Mode	2km	1310nm	0 ~ 60 degrees C
MFB-F20	100	LC	Single Mode	20km	1310nm	0 ~ 60 degrees C
MFB-F40	100	LC	Single Mode	40km	1310nm	0 ~ 60 degrees C
MFB-F60	100	LC	Single Mode	60km	1310nm	0 ~ 60 degrees C
MFB-F120	100	LC	Single Mode	120km	1310nm	0 ~ 60 degrees C

Fast Ethernet Transceiver (100BASE-BX, Single Fiber Bi-directional SFP)

Model	Speed (Mbps)	Connector Interface	Fiber Mode	Distance	Wavelength (TX)	Wavelength (RX)	Operating Temp.
MFB-FA20	100	WDM(LC)	Single Mode	20km	1310nm	1550nm	0 ~ 60 degrees C
MFB-FB20	100	WDM(LC)	Single Mode	20km	1550nm	1310nm	0 ~ 60 degrees C

Available 1000Mbps Modules

Gigabit Ethernet Transceiver (1000BASE-X SFP)

Model	DDM	Speed (Mbps)	Connector Interface	Fiber Mode	Distance	Wavelength (nm)	Operating Temp.
MGB-GT	--	1000	Copper	--	100m	--	0 ~ 60 degrees C
MGB-SX(V2)	YES	1000	LC	Multi Mode	550m	850nm	0 ~ 60 degrees C
MGB-SX2(V2)	YES	1000	LC	Multi Mode	2km	1310nm	0 ~ 60 degrees C
MGB-LX(V2)	YES	1000	LC	Single Mode	20km	1310nm	0 ~ 60 degrees C
MGB-L40	YES	1000	LC	Single Mode	40km	1310nm	0 ~ 60 degrees C
MGB-L80	YES	1000	LC	Single Mode	80km	1550nm	0 ~ 60 degrees C
MGB-L120(V2)	YES	1000	LC	Single Mode	120km	1550nm	0 ~ 60 degrees C

Gigabit Ethernet Transceiver (1000BASE-BX, Single Fiber Bi-directional SFP)

Model	DDM	Speed (Mbps)	Connector Interface	Fiber Mode	Distance	Wavelength (TX)	Wavelength (RX)	Operating Temp.
MGB-LA10(V2)	YES	1000	WDM(LC)	Single Mode	10km	1310nm	1550nm	0 ~ 60 degrees C
MGB-LB10(V2)		1000	WDM(LC)	Single Mode	10km	1550nm	1310nm	0 ~ 60 degrees C
MGB-LA20(V2)	YES	1000	WDM(LC)	Single Mode	20km	1310nm	1550nm	0 ~ 60 degrees C
MGB-LB20(V2)		1000	WDM(LC)	Single Mode	20km	1550nm	1310nm	0 ~ 60 degrees C
MGB-LA40(V2)	YES	1000	WDM(LC)	Single Mode	40km	1310nm	1550nm	0 ~ 60 degrees C
MGB-LB40(V2)		1000	WDM(LC)	Single Mode	40km	1550nm	1310nm	0 ~ 60 degrees C
MGB-LA80	YES	1000	WDM(LC)	Single Mode	80km	1490nm	1550nm	0 ~ 60 degrees C
MGB-LB80		1000	WDM(LC)	Single Mode	80km	1550nm	1490nm	0 ~ 60 degrees C

PLANET Technology Corporation

11F., No.96, Minquan Rd., Xindian Dist., New Taipei City 231, Taiwan (R.O.C.)

Tel: 886-2-2219-9518

Email: sales@planet.com.tw

Fax: 886-2-2219-9528

www.planet.com.tw



GS-4210-16UP4C/GS-4210-24UP4C

PLANET reserves the right to change specifications without prior notice. All brand names and trademarks are property of their respective owners. Copyright © 2023 PLANET Technology Corp. All rights reserved.