

L3 24-Port 10/100/1000T 802.3bt PoE + 2-Port 10GBASE-T + 2-Port 10G SFP+ Managed Switch with Dual Modular Power Supply Slots

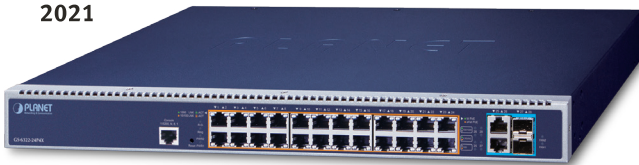

TAIWAN
EXCELLENCE
2021



Powerful 802.3bt PoE++ Managed Switch with Extremely Large Power Capability

PLANET GS-6322-24P4X Fully-managed **802.3bt PoE++** Switch with **dual modular power supply slots** expandability promotes power management efficiency and flexibility in large-scale networks, such as enterprises, hotels, shopping malls, government buildings, and other public areas. It supports rich PoE operation modes including **24 90-watt 802.3bt type-4 PoE++ ports, 95-watt PoH** (Power over HD-BASE-T) mode and 4-pair **force mode** to solve the incompatibility of non-standard 4-pair PoE PDs in the field. With a total power budget of up to **2200 watts** for different kinds of heavy PoE applications, the GS-6322-24P4X provides a quick, safe and cost-effective 802.3bt PoE network solution for small businesses and enterprises.

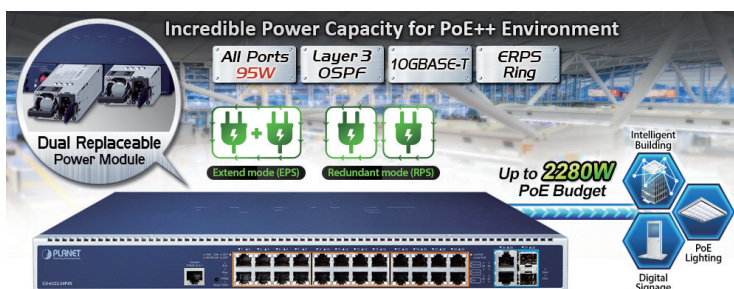

Extractive Power Supply Design to Increase Flexibility

The GS-6322-24P4X is designed with two extractive power module slots to support Redundant Power Supply (RPS) mode or Extended Power Supply (EPS) mode via software setting to handle the demands of power redundancy or additional power for PoE++ ports as needed.

- RPS (1+1) mode: Where critical services are supported by PoE application, the secondary PSU is needed to provide backup power in the event of a power outage. When two PSUs are installed, the power budget is the same as that of one PSU.
- EPS (2+0) mode: Where more PoE budget is required to support complete application, the secondary PSU can provide additional PoE power. The two PSUs combined are able to provide a maximum of total PoE power.

Physical Port

- **24 10/100/1000BASE-T** Gigabit RJ45 copper ports with 24-port **IEEE 802.3bt PoE++** injector function
- **2 10GBASE-T** RJ45 interfaces with auto MDI/MDI-X function
- **2 10GBASE-SR/LR SFP+ slots**, compatible with 1000BASE-SX/LX/BX SFP and 2.5G SFP transceiver
- RJ45 console interface for switch basic management and setup

802.3bt Power over Ethernet

- Complies with IEEE 802.3bt Power over Ethernet Plus Plus
- Backward compatible with IEEE 802.3at Power over Ethernet Plus
- Up to 24 ports of IEEE 802.3af/IEEE 802.3at/IEEE 802.3bt PoE devices powered
- 24 PoE ports with built-in 802.3bt PoE++ Type-4 90W injector function
- Auto detects powered device (PD)
- Circuit protection prevents power interference between ports
- Remote power feeding up to 100 meters
- PoE management features
 - Total PoE power budget control
 - Per port PoE function enable/disable
 - PoE admin-mode control
 - PoE port power feeding priority
 - Per PoE port power limit
 - PD classification detection
 - PoE extend mode control to support power feeding up to a distance of up to 200 meters
- Intelligent PoE features
 - Temperature threshold control
 - PoE usage threshold control
 - PD alive check
 - PoE schedule

Layer 3 Features

- IP dynamic routing protocol supports OSPFv2
- IPv4/IPv6 hardware static routing
- Routing interface provides per VLAN routing mode
- IP interfaces (Max. 128 VLAN interfaces)
- Routing table (Max. 128 routing entries)

The GS-6322-24P4X can work with three optional 920W/1200W/2000W AC power supplies. Users can flexibly use one or dual power supply according to their application. Its flexible redundant and extended power system is specifically designed for high-tech facilities requiring the highest power integrity.

For example

PSU Operation mode	Redundant Power Supply mode	Extended Power System mode
Power Redundancy	■	--
PoE budget with 1 1200W PSU	1000W	1000W
PoE budget with 2 1200W PSUs	1000W	2200W

90~95-watt 802.3bt PoE++ and Advanced PoE Power Output Mode Management

As the GS-6322-24P4X adopts the IEEE 802.3bt PoE++ standard and PoH technology, it is capable to source up to 95 watts of power by using all the four pairs of standard Cat5e/6 Ethernet cabling to deliver power and full-speed data to each remote PoE compliant powered device (PD). To meet the demand of various powered devices consuming stable PoE power, the GS-6322-24P4X PoE++ Switch provides five different PoE power output modes for selection.

- 95W UPOE/PoH
- 90W 802.3bt PoE++
- 60W Force
- 36W End-span PoE
- 36W Mid-span PoE

10GBASE-T and 10GBASE-X SFP Dual Media Interfaces

The GS-6322-24P4X features built-in hardware-based L2 and L3 switching engine along with **24 10/100/1000BASE-T ports**, **2 10GBASE-T RJ45 ports** and **2 additional 10GBASE-X SFP+ ports**. With two built-in 10GBASE-T copper interfaces with **5-speed (10G/5G/2.5G/1G/100)** auto-negotiation, the GS-6322-24P4X provides 10Gbps data transmission with the existing Cat6A/Cat7 UTP cabling, meaning the speed can be increased without costs. The additional **two 10GBASE-X SFP+** interfaces with **3 speeds (10G/2.5G/1G)** are provided for a long-distance transmission of up to 120km.

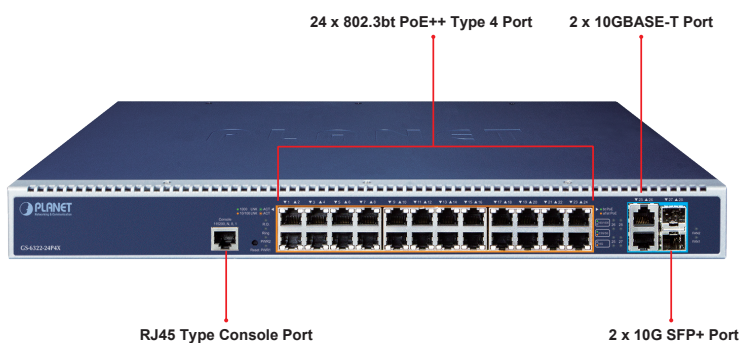

Layer 2 Features

- Prevents packet loss with back pressure (half-duplex) and IEEE 802.3x pause frame flow control (full-duplex)
- High performance of Store-and-Forward architecture and runt/CRC filtering eliminates erroneous packets to optimize the network bandwidth
- Storm Control support
 - Broadcast/multicast/unknown unicast
- Supports **VLAN**
 - IEEE 802.1Q tagged VLAN
 - Out of 4094 VLAN IDs
 - Supports provider bridging (VLAN Q-in-Q, IEEE 802.1ad)
 - Private VLAN Edge (PVE)
 - Protocol-based VLAN
 - MAC-based VLAN
 - Voice VLAN
 - GVRP (GARP VLAN Registration Protocol)
- Supports Spanning Tree Protocol
 - IEEE 802.1D Spanning Tree Protocol (STP)
 - IEEE 802.1w Rapid Spanning Tree Protocol (RSTP)
 - IEEE 802.1s Multiple Spanning Tree Protocol (MSTP), spanning tree by VLAN
 - BPDU Guard
- Supports Link Aggregation
 - 802.3ad Link Aggregation Control Protocol (LACP)
 - Cisco ether-channel (static trunk)
 - Maximum 4 trunk groups with 4 ports for each trunk group
 - Up to 80Gbps bandwidth (full duplex mode)
- Provides port mirror (many-to-1)
- Port mirroring to monitor the incoming or outgoing traffic on a particular port
- Loop protection to avoid broadcast loops
- Supports ERPS (Ethernet Ring Protection Switching)
- Compatible with Cisco uni-directional link detection(UDLD) that monitors a link between two switches and blocks the ports on both ends of the link if the link fails at any point between the two devices
- Link Layer Discovery Protocol (LLDP)

Quality of Service

- Ingress Shaper and Egress Rate Limit per port bandwidth control
- 8 priority queues on all switch ports
- Traffic classification

Layer 3 Routing Support

The GS-6322-24P4X enables the administrator to conveniently boost network efficiency by configuring Layer 3 IPv4/IPv6 VLAN static routing manually, and the IPv4 **OSPFv2** (Open Shortest Path First) settings automatically. The OSPF is an interior dynamic routing protocol for autonomous system based on link state. The protocol creates a database for link state by exchanging link states among Layer 3 switches, and then uses the Shortest Path First algorithm to generate a route table based on that database.

Redundant Ring, Fast Recovery for Critical Network Applications

The GS-6322-24P4X supports redundant ring technology and features strong, rapid self-recovery capability to prevent interruptions and external intrusions. It incorporates advanced **ITU-T G.8032 ERPS (Ethernet Ring Protection Switching)** technology, Spanning Tree Protocol (802.1s MSTP), and **redundant power** input system into customer's industrial automation network to enhance system reliability and uptime in harsh factory environments. In a certain simple Ring network, the recovery time of data link can be as fast as 10ms.

Convenient and Smart ONVIF Devices with Detection Feature

The GS-6322-24P4X supports an awesome feature -- **ONVIF Support** -- which is specifically designed for co-operating with Video IP Surveillances. From its GUI, clients just need one click to search and show all of the ONVIF devices via network application. In addition, clients can upload floor images to a switch and it allows you to deploy any surveillance devices for easier inspection and planning. Moreover, clients can get real-time surveillance's information and online/offline status, and also allows PoE reboot control from GUI.

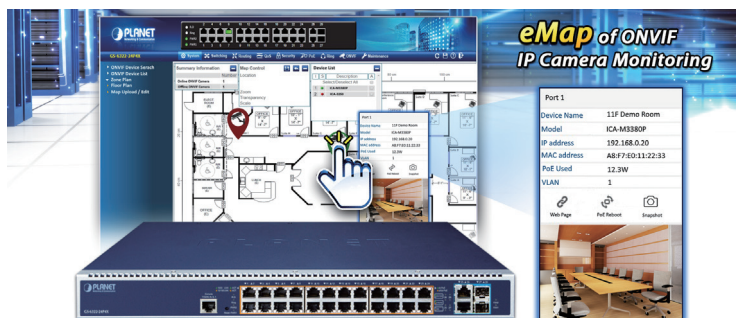
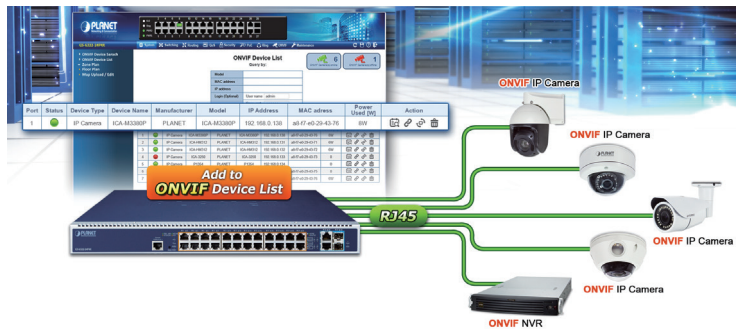

- IEEE 802.1p CoS
- TOS/DSCP/IP precedence of IPv4/IPv6 packets
- IP TCP/UDP port number
- Typical network application
- Strict priority and Weighted Round Robin (WRR) CoS policies
- Supports QoS and In/Out bandwidth control on each port
- Traffic-policing on the switch port
- DSCP remarking

Multicast

- Supports IPv4 IGMP snooping v1, v2 and v3
- Supports IPv6 MLD snooping v1 and v2
- Querier mode support
- IPv4 IGMP snooping port filtering
- IPv6 MLD snooping port filtering
- Multicast VLAN Registration (MVR) support

Security

- Authentication
 - IEEE 802.1x port-based/MAC-based network access authentication
 - Built-in RADIUS client to cooperate with the RADIUS servers
 - TACACS+ login users access authentication
 - RADIUS/TACACS+ users access authentication
 - Guest VLAN assigns clients to a restricted VLAN with limited services.
- Access Control List
 - IP-based Access Control List (ACL)
 - MAC-based Access Control List
- Source MAC/IP address binding
- DHCP Snooping to filter untrusted DHCP messages
- Dynamic ARP Inspection discards ARP packets with invalid MAC address to IP address binding
- IP Source Guard prevents IP spoofing attacks
- IP address access management to prevent unauthorized intruder

Management

- IPv4 and IPv6 dual stack management
- Switch Management Interfaces
 - Console/Telnet Command Line Interface
 - Web switch management
 - SNMP v1, v2c, and v3 switch management

Built-in Unique PoE Functions for Powered Devices Management

Being the managed PoE switch for surveillance, wireless and VoIP networks, the GS-6322-24P4X features the following special PoE management functions:

- PD alive check
- Scheduled power recycling
- PoE schedule
- PoE usage monitoring

Intelligent Powered Device Alive Check

The GS-6322-24P4X can be configured to monitor connected PD (powered device) status in real time via ping action. Once the PD stops working and responding, the GS-6322-24P4X will resume the PoE port power and bring the PD back to work. It will greatly enhance the network reliability through the PoE port resetting the PD's power source and reducing administrator management burden.

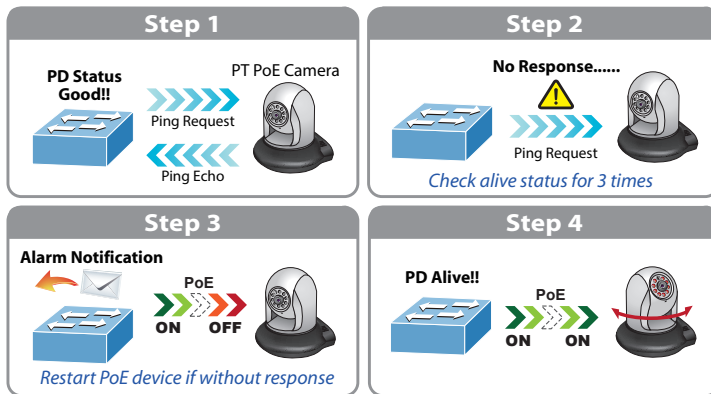

Scheduled Power Recycling

The GS-6322-24P4X allows each of the connected PoE IP cameras or PoE wireless access points to reboot at a specified time each week. Therefore, they will reduce the chance of IP camera or AP crash resulting from buffer overflow.

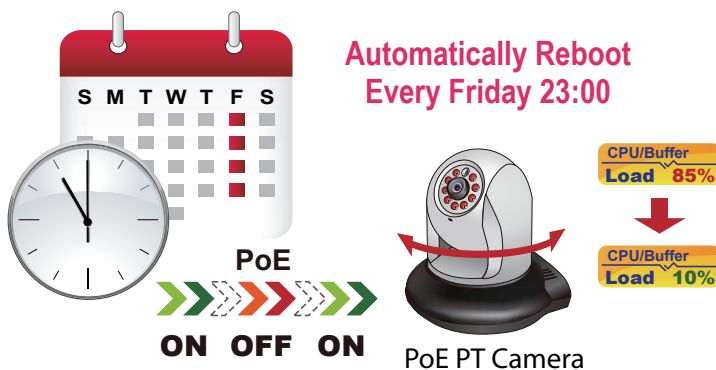

PoE Schedule for Energy Savings

Under the trend of energy savings worldwide and contributing to environmental protection, the GS-6322-24P4X can effectively control the power supply besides their capability of giving high watts power. The "PoE schedule" function helps you to enable or disable PoE power feeding for each PoE port during specified time

- SSHv2, TLSv1.2, SSL and SNMP v3 secure access
- SNMP Management
 - Four RMON groups (history, statistics, alarms and events)
 - SNMP trap for interface Link Up and Link Down notification
- IPv6 IP address/NTP/DNS management
- Built-in Trivial File Transfer Protocol (TFTP) client
- BOOTP and DHCP for IP address assignment
- System Maintenance
 - Firmware upload/download via HTTP/TFTP
 - Reset button for system reboot or reset to factory default
 - Dual images
- DHCP Relay and DHCP Option 82
- DHCP Server
- User Privilege levels control
- NTP (Network Time Protocol)
- Network Diagnostic
 - SFP-DDM (Digital Diagnostic Monitor)
 - ICMPv6/ICMPv4 remote ping
 - Cable diagnostic technology provides the mechanism to detect and report potential cabling issues
- SMTP/Syslog remote alarm
- System Log
- PLANET Smart Discovery Utility for deployment management
- Smart fan with speed control

Power Management

- Dual redundant modular power supply slots
- Supports configurable power operation modes
 - Redundant Power Supply (RPS, 1+1): Provides 1+1 power redundancy when two PSUs are installed.
 - Extended Power Supply (EPS, 2+0): Provides more power budget by combining two PSUs to share the maximum power budget
- Active-active redundant power failure protection
- Backup of catastrophic power failure on one supply
- Fault tolerance and resilience

intervals and it is a powerful function to help SMBs or enterprises save power and money. It also increases security by powering off PDs that should not be in use during non-business hours.

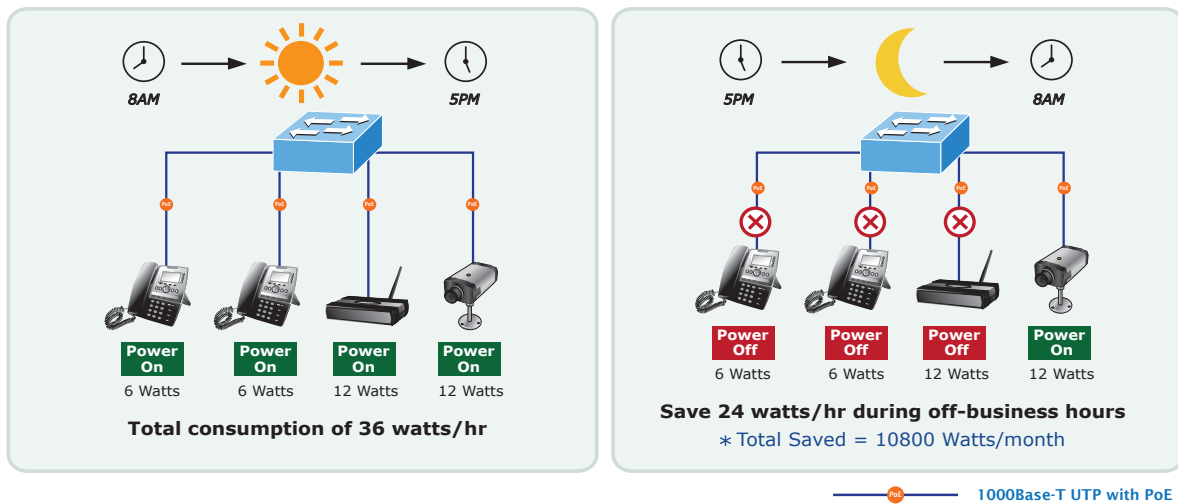

Robust Layer 2 Features

The GS-6322-24P4X can be programmed for advanced Layer 2 switch management functions such as dynamic port link aggregation, 802.1Q tagged VLAN, **Q-in-Q VLAN**, private VLAN, Multiple Spanning Tree Protocol (**MSTP**), Layer 2 to Layer 4 QoS, bandwidth control, **IGMP snooping** and **MLD snooping**. Via the aggregation of supporting ports, the GS-6322-24P4X can operate at high speed as it comes with multiple ports and supports fail-over as well.

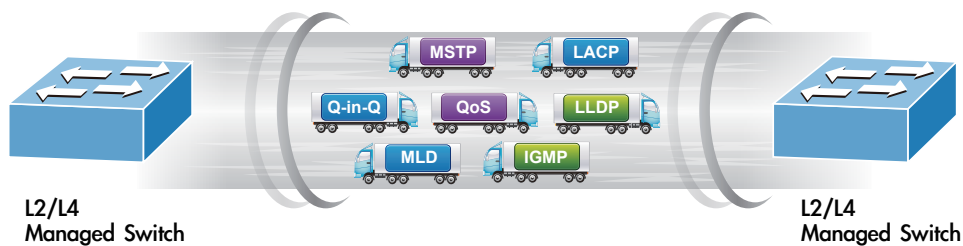

Powerful Network Security

The GS-6322-24P4X offers a comprehensive **Layer 2 to Layer 4 access control list (ACL)** for enforcing security to the edge. It can be used to restrict to network access by denying packets based on source and destination IP address, TCP/UDP port number or defined typical network applications. Its protection mechanism also comprises **802.1x Port-based** and **MAC-based** user and device authentication. With the **private VLAN** function, communication between edge ports can be prevented to ensure user privacy.

Advanced IP Network Protection

The GS-6322-24P4X also provides **DHCP Snooping**, **IP Source Guard** and **Dynamic ARP Inspection** functions to prevent IP snooping from attack and discard ARP packets with invalid MAC address. The network administrator can now construct highly-secure corporate networks with considerably less time and effort than before.

Efficient Management

For efficient management, the GS-6322-24P4X is equipped with console, Web and SNMP management interfaces.

- With the built-in **Web-based** management interface, it offers an easy-to-use, platform-independent management and configuration facility.
- For **text-based** management, it can be accessed via Telnet and the console port.
- For standard-based monitor and management software, it offers SNMPv3 connection which encrypts the packet content at each session for secure remote management.



Intelligent SFP/SFP+ Diagnosis Mechanism

The GS-6322-24P4X supports **SFP-DDM (Digital Diagnostic Monitor)** function that greatly helps network administrator to easily monitor real-time parameters of the SFP and SFP+ transceivers, such as optical output power, optical input power, temperature, laser bias current, and transceiver supply voltage.

Digital Diagnostic Monitor (DDM)

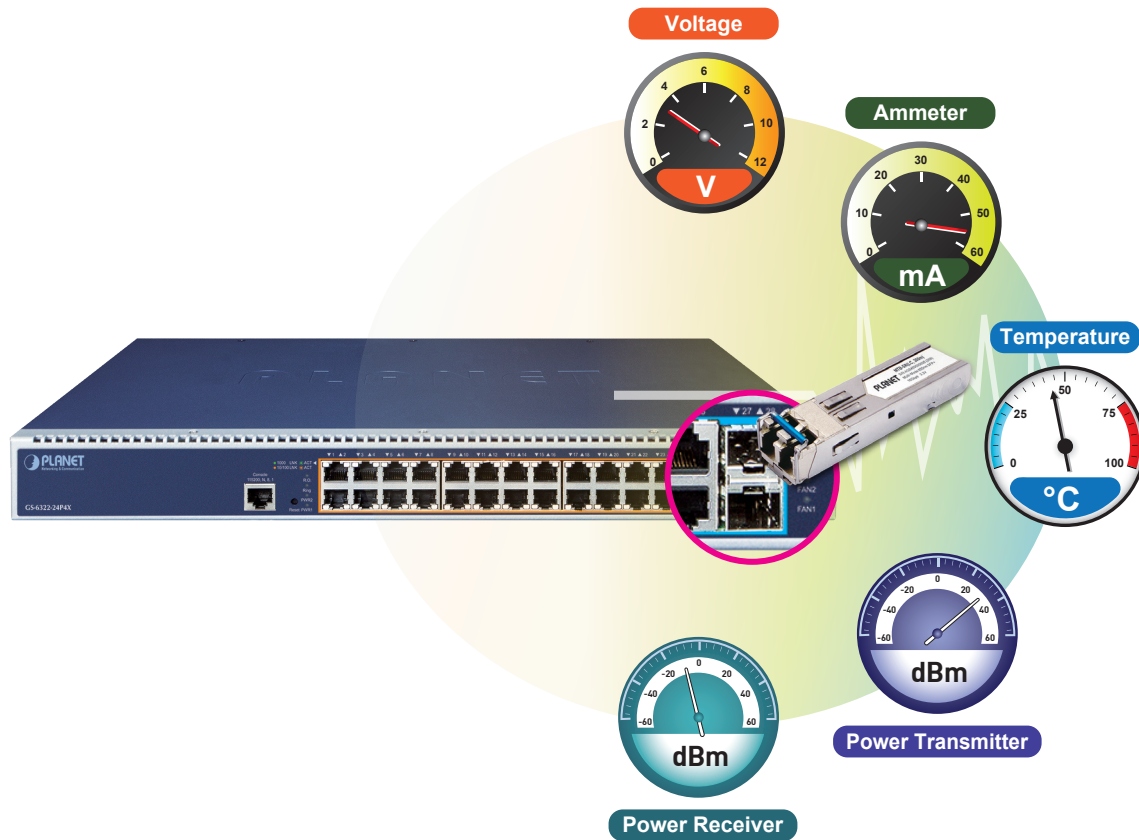

Applications

IEEE 802.3bt/ Ultra PoE Networking Solution

PLANET GS-6322-24P4X can easily build an ultra PoE networking solution on the cyber security system for the enterprises. For instance, it can work with the POS system and thin client to perform comprehensive security protection for today's businesses. The GS-6322-24P4X and POE-173S/IPOE-173S 802.3bt PoE++ Splitter operate as a pair to provide the easiest way to power your Ethernet devices which need high power input. Receiving data and power from the GS-6322-24P4X, the POE-173S/IPOE-173S separates digital data and power into several optional outputs (12V, 19V or 24V DC) to non-PoE devices such as laptops, thin client, POS system, PTZ (pan, tilt & zoom) network cameras, PTZ speed dome cameras, color touch-screen IP phones, multi-channel wireless LAN access points and other network devices at distance up to 100 meters.

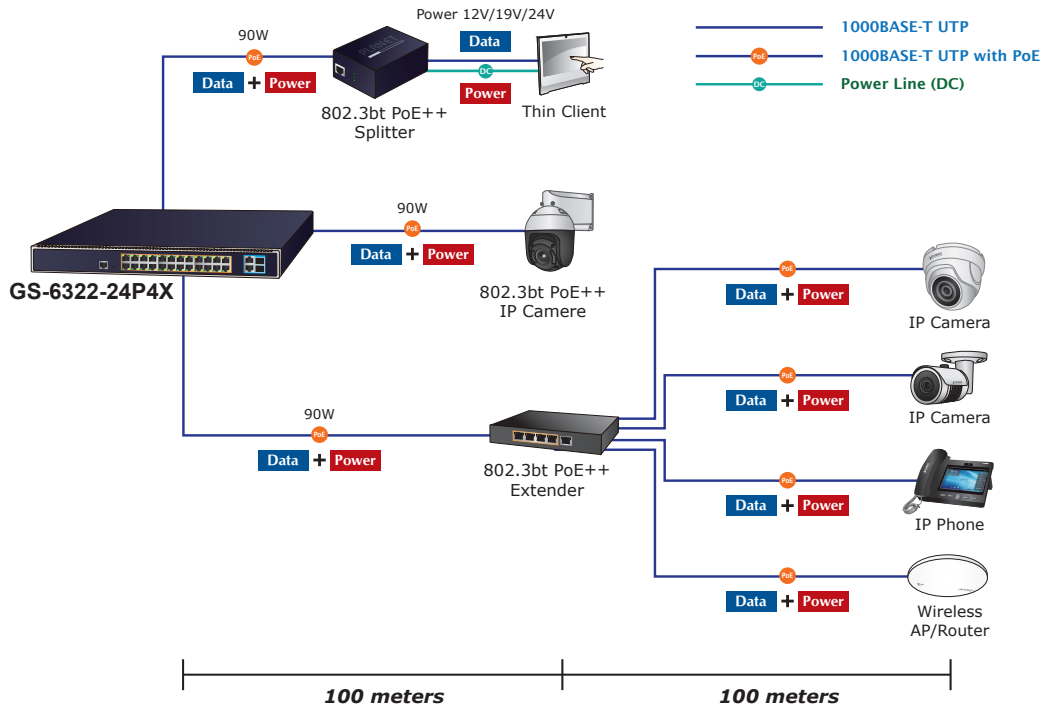

Optimal Redundant Ring for Faster Recovery of Managed Network

The GS-6322-24P4X supports redundant ring technology and features strong, rapid self-recovery capability to prevent interruptions and external intrusions. It incorporates advanced ITU-T G.8032 ERPS (**Ethernet Ring Protection Switching**) technology, and Spanning Tree Protocol (802.1w RSTP) into customer's network to enhance system reliability and uptime in harsh environments. In a certain simple ring network, the recovery time could be less than 10ms to quickly bring the network back, thus enabling the management network to keep on operating.

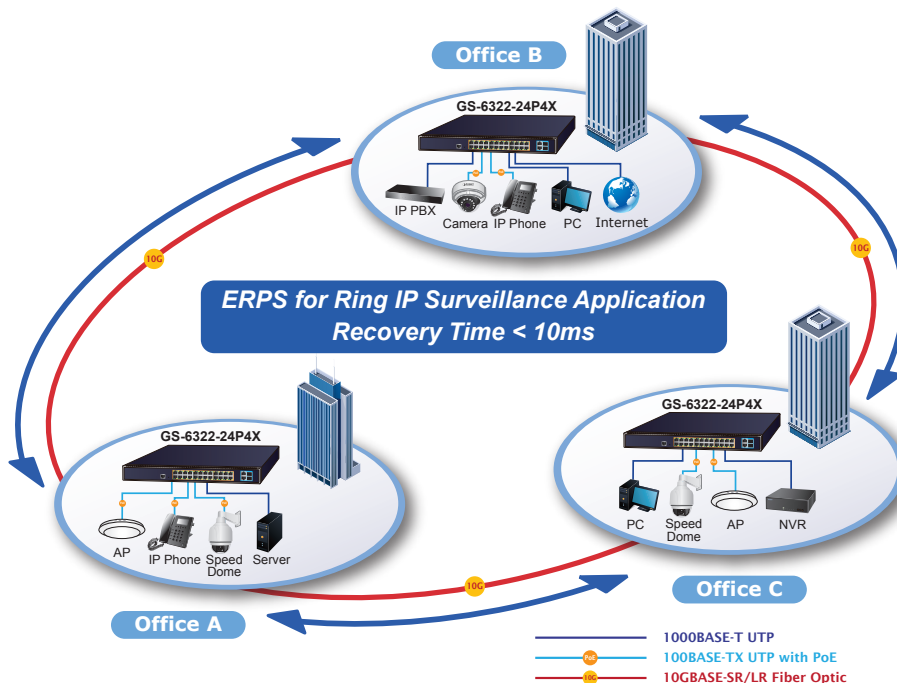

Specifications

Product	GS-6322-24P4X
Hardware Specifications	
Copper Ports	24 10/100/1000BASE-T RJ45 auto-MDI/MDI-X ports 2-port 10GBASE-T RJ45 auto negotiation (Port-25 to Port-26), supports 10G/5G/2.5G/1G/100Mbps data rate
SFP+ Slots	2 10GBASE-SR/LR SFP+ interfaces (Port-27 to Port-28) Compatible with 1000BASE-SX/LX/BX SFP and 2.5G SFP transceiver
Console	1 x RS232-to-RJ45 serial port (115200, 8, N, 1)
Reset Button	< 5 sec: System reboot > 5 sec: Factory default
Dimensions (W x D x H)	440x300x44mm, 1U height
Weight	5478g
Power Consumption	Single PSU: Max. 2032 watts/ 6933 BTU Dual PSUs in EPS mode: Max. 2377 watts/ 8111 BTU
Power Requirements	Single 2000W PSU: AC 100~240V, 50/60Hz, 13A Dual 2000W PSUs: AC 100~240V, 50/60Hz, 26A
ESD Protection	6KV DC
Fan	2 smart fans
LED	System: SYS (Green) PWR1 (Green) PWR2 (Green) Ring (Green) Fan1/2/3 Alert (Red) PoE PWR Alert (Red) PoE Ethernet Interfaces (Port-1 to Port-24): af/at PoE (Orange) bt PoE/UPOE (Green) Ethernet Interfaces (Port-1 to Port-24): 1000 LNK/ACT (Green), 10/100 LNK/ACT (Orange) 1/10G SFP+ Interfaces (Port-27 to Port-28): 1G (Green), 10G (Orange)
Network Cables	10G/5G/2.5G/1G/100M BASE-T: -10G – Cat 6A/7 -5G – Cat 6/6A/7 -1G/2.5G – Cat 5e/6/6A/7 -100M – Cat 5/5e/6/6A/7 -Cat 5/5e/6/6A/7 UTP cable (maximum 100 meters) 10GBASE-LR/SR/BX: -50/125µm or 62.5/125µm multi-mode fiber optic cable, up to 300m -9/125µm single-mode fiber optic cable, up to 60km
Switching	
Switch Architecture	Store-and-Forward
Switch Fabric	128Gbps/non-blocking
Throughput	95.23Mpps@64Bytes
Address Table	16K entries, automatic source address learning and aging
Shared Data Buffer	32M bits
Flow Control	IEEE 802.3x pause frame for full duplex Back pressure for half duplex
RING	Support ERPS, complies with ITU-T G.8032 Recovery time < 10ms with 3 units Recovery time < 50ms with 16 units
Jumbo Frame	10K bytes
Power over Ethernet	
PoE Standard	802.3bt PoE++ PSE Backward compatible with IEEE 802.3af/802.3at PoE PSE
PoE Power Supply Type	<ul style="list-style-type: none"> ■ 802.3bt ■ UPoE ■ End-span ■ Mid-span ■ Force

PoE Power Output	<p>Per port 54V DC</p> <ul style="list-style-type: none"> -802.3bt Type-4 mode, Port-1 to Port-24: maximum 90 watts -UPoE mode, Port-1 to Port-24: maximum 95 watts -End-span mode: maximum 36 watts -Mid-span mode: maximum 36 watts -Force mode: maximum 60 watts 																																																																																										
Power Pin Assignment	<ul style="list-style-type: none"> ■ 802.3bt: 1/2(-), 3/6(+), 4/5(+), 7/8(-) ■ UPoE: 1/2(-), 3/6(+), 4/5(+), 7/8(-) ■ End-span: 1/2(-), 3/6(+) ■ Mid-span: 4/5(+), 7/8(-) 																																																																																										
PoE Power Budget	<p>Input Power: 110V</p> <table border="1"> <thead> <tr> <th colspan="2">Slot1 \ Slot2</th> <th>-</th> <th>920</th> <th>1200</th> <th>2000</th> </tr> <tr> <th colspan="2"></th> <th></th> <th>Power</th> <th>Power</th> <th>Power</th> </tr> </thead> <tbody> <tr> <td rowspan="2">920 Power</td> <td>RPS (Watt)</td> <td>720</td> <td>720</td> <td>720</td> <td>720</td> </tr> <tr> <td>EPS (Watt)</td> <td>720</td> <td>1640</td> <td>1720</td> <td>1720</td> </tr> <tr> <td rowspan="2">1200 Power</td> <td>RPS (Watt)</td> <td>800</td> <td>720</td> <td>800</td> <td>800</td> </tr> <tr> <td>EPS (Watt)</td> <td>800</td> <td>1720</td> <td>1800</td> <td>1800</td> </tr> <tr> <td rowspan="2">2000 Power</td> <td>RPS (Watt)</td> <td>800</td> <td>720</td> <td>800</td> <td>800</td> </tr> <tr> <td>EPS (Watt)</td> <td>800</td> <td>1720</td> <td>1800</td> <td>1800</td> </tr> </tbody> </table> <p>Input Power: 220V</p> <table border="1"> <thead> <tr> <th colspan="2">Slot1 \ Slot2</th> <th>-</th> <th>920</th> <th>1200</th> <th>2000</th> </tr> <tr> <th colspan="2"></th> <th></th> <th>Power</th> <th>Power</th> <th>Power</th> </tr> </thead> <tbody> <tr> <td rowspan="2">920 Power</td> <td>RPS (Watt)</td> <td>720</td> <td>720</td> <td>720</td> <td>720</td> </tr> <tr> <td>EPS (Watt)</td> <td>720</td> <td>1640</td> <td>1920</td> <td>2280</td> </tr> <tr> <td rowspan="2">1200 Power</td> <td>RPS (Watt)</td> <td>1000</td> <td>720</td> <td>1000</td> <td>1000</td> </tr> <tr> <td>EPS (Watt)</td> <td>1000</td> <td>1920</td> <td>2200</td> <td>2280</td> </tr> <tr> <td rowspan="2">2000 Power</td> <td>RPS (Watt)</td> <td>1600</td> <td>720</td> <td>1000</td> <td>1800</td> </tr> <tr> <td>EPS (Watt)</td> <td>1600</td> <td>2280</td> <td>2280</td> <td>2280</td> </tr> </tbody> </table>	Slot1 \ Slot2		-	920	1200	2000				Power	Power	Power	920 Power	RPS (Watt)	720	720	720	720	EPS (Watt)	720	1640	1720	1720	1200 Power	RPS (Watt)	800	720	800	800	EPS (Watt)	800	1720	1800	1800	2000 Power	RPS (Watt)	800	720	800	800	EPS (Watt)	800	1720	1800	1800	Slot1 \ Slot2		-	920	1200	2000				Power	Power	Power	920 Power	RPS (Watt)	720	720	720	720	EPS (Watt)	720	1640	1920	2280	1200 Power	RPS (Watt)	1000	720	1000	1000	EPS (Watt)	1000	1920	2200	2280	2000 Power	RPS (Watt)	1600	720	1000	1800	EPS (Watt)	1600	2280	2280	2280
Slot1 \ Slot2		-	920	1200	2000																																																																																						
			Power	Power	Power																																																																																						
920 Power	RPS (Watt)	720	720	720	720																																																																																						
	EPS (Watt)	720	1640	1720	1720																																																																																						
1200 Power	RPS (Watt)	800	720	800	800																																																																																						
	EPS (Watt)	800	1720	1800	1800																																																																																						
2000 Power	RPS (Watt)	800	720	800	800																																																																																						
	EPS (Watt)	800	1720	1800	1800																																																																																						
Slot1 \ Slot2		-	920	1200	2000																																																																																						
			Power	Power	Power																																																																																						
920 Power	RPS (Watt)	720	720	720	720																																																																																						
	EPS (Watt)	720	1640	1920	2280																																																																																						
1200 Power	RPS (Watt)	1000	720	1000	1000																																																																																						
	EPS (Watt)	1000	1920	2200	2280																																																																																						
2000 Power	RPS (Watt)	1600	720	1000	1800																																																																																						
	EPS (Watt)	1600	2280	2280	2280																																																																																						
PoE Management Functions																																																																																											
Active PoE device alive detects	Yes																																																																																										
PoE Power Recycle	Yes, daily or predefined schedule																																																																																										
PoE Schedule	4 schedule profiles																																																																																										
PoE Extend Mode	Yes, max. 160 to 200 meters																																																																																										
PoE System Management	<ul style="list-style-type: none"> System PoE Admin control Total PoE power budget control Auto power input and PoE budget control PoE Legacy mode Over-temperature threshold alarm PoE usage threshold alarm 																																																																																										
PoE Port Management	<ul style="list-style-type: none"> Port Enable/Disable/Schedule PoE mode control - 802.3bt - UPoE - 802.3at End-span - 802.3at Mid-span Force mode Port Priority 																																																																																										
Layer 3 Functions																																																																																											
IP Interfaces	Max. 128 VLAN interfaces																																																																																										
Routing Table	Max. 128 routing entries																																																																																										
Routing Protocols	<ul style="list-style-type: none"> IPv4 OSPFv2 IPv4 hardware static routing IPv6 hardware static routing 																																																																																										
Layer 2 Management Functions																																																																																											
Port Configuration	<ul style="list-style-type: none"> Port disable/enable Auto-negotiation 10/100/1000Mbps full and half duplex mode selection Flow control disable/enable Port link capability control 																																																																																										
Port Status	Display each port's speed duplex mode, link status, flow control status,																																																																																										
Port Mirroring	<ul style="list-style-type: none"> TX/RX/Both Many-to-1 monitor 																																																																																										

VLAN	<p>802.1Q tagged VLAN Q-in-Q tunneling Private VLAN Edge (PVE) MAC-based VLAN Protocol-based VLAN Voice VLAN MVR (Multicast VLAN registration) Out of 4095 VLAN IDs</p>	
Link Aggregation	<p>IEEE 802.3ad LACP/static trunk Supports 3 trunk groups with 4 ports per trunk group</p>	
Spanning Tree Protocol	<p>IEEE 802.1D Spanning Tree Protocol (STP) IEEE 802.1w Rapid Spanning Tree Protocol (RSTP) IEEE 802.1s Multiple Spanning Tree Protocol (MSTP)</p>	
IGMP Snooping	<p>IPv4 IGMP (v1/v2/v3) snooping IPv4 IGMP querier mode support Supports 255 IGMP groups</p>	
MLD Snooping	<p>IPv6 MLD (v1/v2) snooping, IPv6 MLD querier mode support Supports 255 MLD groups</p>	
QoS	<p>Traffic classification based, strict priority and WRR 8-level priority for switching: - Port number - 802.1p priority - 802.1Q VLAN tag - DSCP/ToS field in IP packet</p>	
Access Control List	<p>IP-based ACL/MAC-based ACL ACL based on: - MAC Address - IP Address - Ethertype - Protocol Type - VLAN ID - DSCP - 802.1p Priority Up to 256 entries</p>	
Bandwidth Control	<p>Per port bandwidth control Ingress: 100Kbps~1000Mbps Egress: 100Kbps~1000Mbps</p>	
Management		
Basic Management Interfaces	<p>Console; Telnet; Web browser; SNMP v1, v2c</p>	
Secure Management Interfaces	<p>SSHv2, TLSv1.2, SSL, SNMP v3</p>	
SNMP MIBs	<p>RFC 1213 MIB-II RFC 1493 Bridge MIB RFC 1643 Ethernet MIB RFC 2863 Interface MIB RFC 2665 Ether-Like MIB RFC 2819 RMON MIB (Groups 1, 2, 3 and 9) RFC 2737 Entity MIB RFC 2618 RADIUS Client MIB RFC 2863 IF-MIB</p>	<p>RFC 2933 IGMP-STD-MIB RFC 3411 SNMP-Frameworks-MIB RFC 4292 IP Forward MIB RFC 4293 IP MIB RFC 4836 MAU-MIB IEEE 802.1X PAE LLDP MAU-MIB</p>
Standards Conformance		
Standards Compliance	<p>IEEE 802.3 10BASE-T IEEE 802.3u 100BASE-TX/100BASE-FX IEEE 802.3z Gigabit SX/LX IEEE 802.3ab Gigabit 1000T IEEE 802.3ae 10Gb/s Ethernet IEEE 802.3x flow control and back pressure IEEE 802.3ad port trunk with LACP IEEE 802.1D Spanning Tree Protocol IEEE 802.1w Rapid Spanning Tree Protocol IEEE 802.1s Multiple Spanning Tree Protocol IEEE 802.1p Class of Service IEEE 802.1Q VLAN tagging IEEE 802.1x Port Authentication Network Control IEEE 802.1ab LLDP IEEE 802.3af Power over Ethernet IEEE 802.3at Power over Ethernet Plus</p>	<p>IEEE 802.3bt PoE++ Power over Ethernet Plus Plus IEEE 802.3ah OAM IEEE 802.1ag Connectivity Fault Management (CFM) RFC 768 UDP RFC 793 TFTP RFC 791 IP RFC 792 ICMP RFC 2068 HTTP RFC 1112 IGMP v1 RFC 2236 IGMP v2 RFC 3376 IGMP v3 RFC 2710 MLD v1 RFC 3810 MLD v2 RFC 2328 OSPF v2 ITU-T G.8032 ERPS Ring ITU-T Y.1731 Performance Monitoring</p>

Environments

Operating	Temperature: 0 ~ 50 degrees C Relative Humidity: 5 ~ 95% (non-condensing)
Storage	Temperature: -10 ~ 70 degrees C Relative Humidity: 5 ~ 95% (non-condensing)

Dimensions

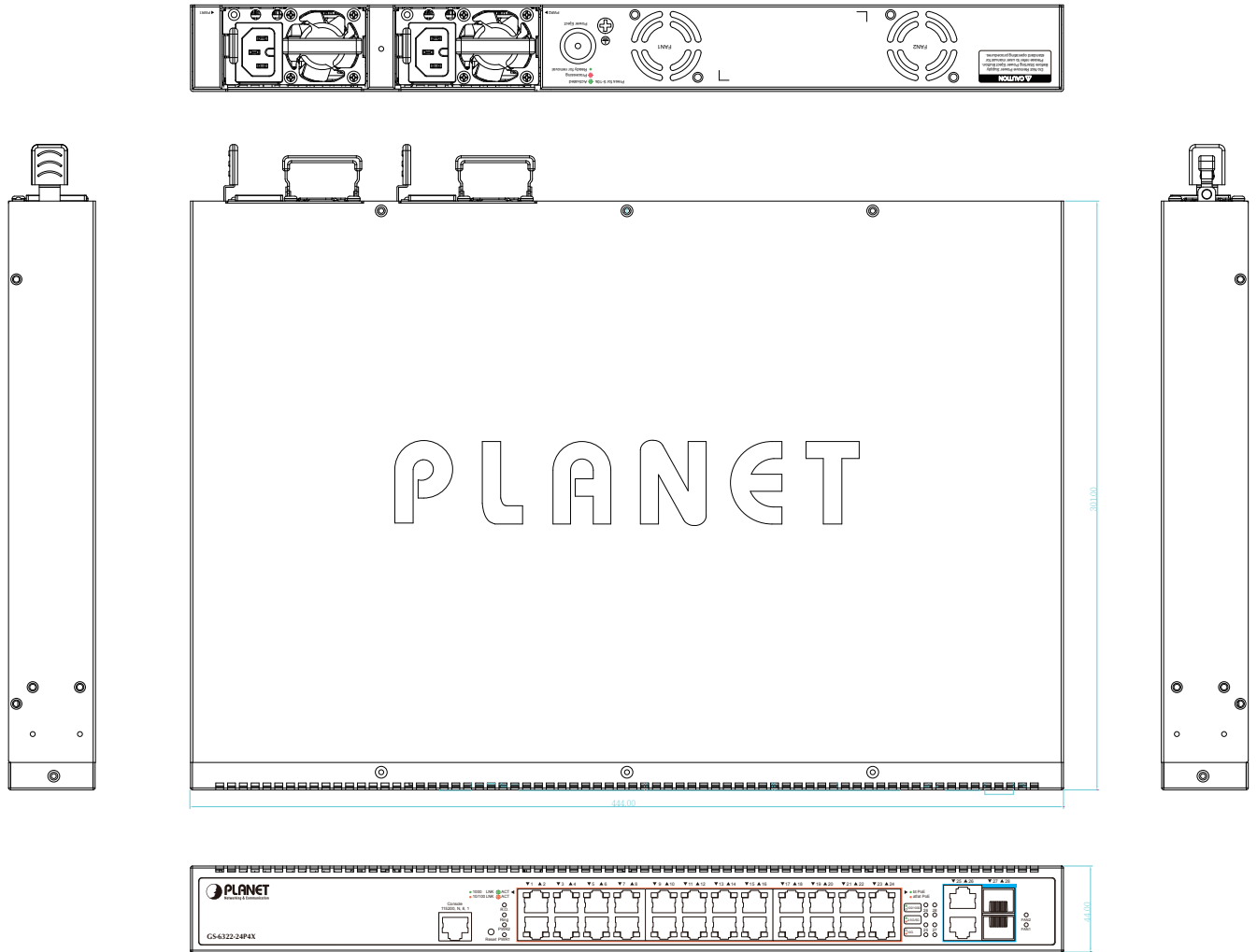

Unit : mm

Ordering Information

GS-6322-24P4X	L3 24-Port 10/100/1000T 802.3bt PoE + 2-Port 10GBASE-T + 2-Port 10G SFP+ Managed Switch with Dual Modular Power Supply Slots
PWR-CRPS1200	1200W CRPS Power Supply, 100-240VAC
PWR-CRPS2000	2000W CRPS Power Supply, 100-240VAC
PWR-CRPS920	920W CRPS Power Supply, 100-240VAC

Related Products

GS-5220-24P4XV	L2+ 24-Port 10/100/1000T Ultra PoE + 4-Port 10G SFP+ Managed Switch with LCD Touch Screen (400W)
GS-5220-24P4XVR	L2+ 24-Port 10/100/1000T Ultra PoE + 4-Port 10G SFP+ Managed Switch with LCD Touch Screen and Redundant Power (400W)
GS-5220-24UPL4XV	L2+ 24-Port 10/100/1000T Ultra PoE + 4-Port 10G SFP+ Managed Switch with LCD Touch Screen (600W)
GS-5220-24UPL4XVR	L2+ 24-Port 10/100/1000T Ultra PoE + 4-Port 10G SFP+ Managed Switch with LCD Touch Screen and Redundant Power (600W)

Available Modules

10Gigabit Ethernet Transceiver (10GBASE-X SFP+)

Model	Speed (Mbps)	Connector Interface	Fiber Mode	Distance	Wavelength (nm)	Operating Temp.
MTB-RJ	10G	Copper	--	30m	--	0 ~ 70 degrees C
MTB-SR	10G	LC	Multi Mode	300m	850nm	0 ~ 60 degrees C
MTB-LR	10G	LC	Single Mode	10km	1310nm	0 ~ 60 degrees C
MTB-TSR	10G	LC	Multi Mode	300m	850nm	-40 ~ 75 degrees C
MTB-TLR	10G	LC	Single Mode	10km	1310nm	-40 ~ 75 degrees C

10Gigabit Ethernet Transceiver (10GBASE-BX, Single Fiber Bi-directional SFP)

Model	Speed (Mbps)	Connector Interface	Fiber Mode	Distance	Wavelength (TX)	Wavelength (RX)	Operating Temp.
MTB-LA20	10G	WDM(LC)	Single Mode	20km	1270nm	1330nm	0 ~ 60 degrees C
MTB-LB20	10G	WDM(LC)	Single Mode	20km	1330nm	1270nm	0 ~ 60 degrees C
MTB-LA40	10G	WDM(LC)	Single Mode	40km	1270nm	1330nm	0 ~ 60 degrees C
MTB-LB40	10G	WDM(LC)	Single Mode	40km	1330nm	1270nm	0 ~ 60 degrees C
MTB-LA60	10G	WDM(LC)	Single Mode	60km	1270nm	1330nm	0 ~ 60 degrees C
MTB-LB60	10G	WDM(LC)	Single Mode	60km	1330nm	1270nm	0 ~ 60 degrees C

Gigabit Ethernet Transceiver (1000BASE-X SFP)

Model	DDM	Speed (Mbps)	Connector Interface	Fiber Mode	Distance	Wavelength (nm)	Operating Temp.
MGB-GT	--	1000	Copper	--	100m	--	0 ~ 60 degrees C
MGB-SX(V2)	YES	1000	LC	Multi Mode	550m	850nm	0 ~ 60 degrees C
MGB-SX2(V2)	YES	1000	LC	Multi Mode	2km	1310nm	0 ~ 60 degrees C
MGB-LX(V2)	YES	1000	LC	Single Mode	20km	1310nm	0 ~ 60 degrees C
MGB-L40	YES	1000	LC	Single Mode	40km	1310nm	0 ~ 60 degrees C
MGB-L80	YES	1000	LC	Single Mode	80km	1550nm	0 ~ 60 degrees C
MGB-L120(V2)	YES	1000	LC	Single Mode	120km	1550nm	0 ~ 60 degrees C
MGB-TSX	YES	1000	LC	Multi Mode	550m	850nm	-40 ~ 75 degrees C
MGB-TSX2	YES	1000	LC	Multi Mode	2km	1310nm	-40 ~ 75 degrees C
MGB-TLX(V2)	YES	1000	LC	Single Mode	20km	1310nm	-40 ~ 75 degrees C
MGB-TL40	YES	1000	LC	Single Mode	40km	1310nm	-40 ~ 75 degrees C
MGB-TL80	YES	1000	LC	Single Mode	80km	1550nm	-40 ~ 75 degrees C
MGB-L120(V2)	YES	1000	LC	Single Mode	120km	1550nm	0 ~ 60 degrees C

Gigabit Ethernet Transceiver (1000BASE-BX, Single Fiber Bi-directional SFP)

Model	DDM	Speed (Mbps)	Connector Interface	Fiber Mode	Distance	Wavelength (TX)	Wavelength (RX)	Operating Temp.
MGB-LA10(V2)	YES	1000	WDM(LC)	Single Mode	10km	1310nm	1550nm	0 ~ 60 degrees C
MGB-LB10(V2)		1000	WDM(LC)	Single Mode	10km	1550nm	1310nm	0 ~ 60 degrees C
MGB-LA20(V2)	YES	1000	WDM(LC)	Single Mode	20km	1310nm	1550nm	0 ~ 60 degrees C
MGB-LB20(V2)		1000	WDM(LC)	Single Mode	20km	1550nm	1310nm	0 ~ 60 degrees C
MGB-LA40(V2)	YES	1000	WDM(LC)	Single Mode	40km	1310nm	1550nm	0 ~ 60 degrees C
MGB-LB40(V2)		1000	WDM(LC)	Single Mode	40km	1550nm	1310nm	0 ~ 60 degrees C
MGB-LA80	YES	1000	WDM(LC)	Single Mode	80km	1490nm	1550nm	0 ~ 60 degrees C
MGB-LB80		1000	WDM(LC)	Single Mode	80km	1550nm	1490nm	0 ~ 60 degrees C
MGB-TLA10(V2)	YES	1000	WDM(LC)	Single Mode	10km	1310nm	1550nm	-40 ~ 75 degrees C
MGB-TLB10(V2)		1000	WDM(LC)	Single Mode	10km	1550nm	1310nm	-40 ~ 75 degrees C
MGB-TLA20	YES	1000	WDM(LC)	Single Mode	20km	1310nm	1550nm	-40 ~ 75 degrees C
MGB-TLB20		1000	WDM(LC)	Single Mode	20km	1550nm	1310nm	-40 ~ 75 degrees C
MGB-TLA40	YES	1000	WDM(LC)	Single Mode	40km	1310nm	1550nm	-40 ~ 75 degrees C
MGB-TLB40		1000	WDM(LC)	Single Mode	40km	1550nm	1310nm	-40 ~ 75 degrees C
MGB-TLA80	YES	1000	WDM(LC)	Single Mode	80km	1490nm	1550nm	-40 ~ 75 degrees C
MGB-TLB80		1000	WDM(LC)	Single Mode	80km	1550nm	1490nm	-40 ~ 75 degrees C

Fast Ethernet Transceiver (100BASE-X SFP)

Model	Speed (Mbps)	Connector Interface	Fiber Mode	Distance	Wavelength (nm)	Operating Temp.
MFB-FX	100	LC	Multi Mode	2km	1310nm	0 ~ 60 degrees C
MFB-F20	100	LC	Single Mode	20km	1310nm	0 ~ 60 degrees C
MFB-F40	100	LC	Single Mode	40km	1310nm	0 ~ 60 degrees C
MFB-F60	100	LC	Single Mode	60km	1310nm	0 ~ 60 degrees C
MFB-F120	100	LC	Single Mode	120km	1310nm	0 ~ 60 degrees C
MFB-TFX	100	LC	Multi Mode	2km	1310nm	-40 ~ 75 degrees C
MFB-TF20	100	LC	Single Mode	20km	1310nm	-40 ~ 75 degrees C

Fast Ethernet Transceiver (100BASE-BX, Single Fiber Bi-directional SFP)

Model	Speed (Mbps)	Connector Interface	Fiber Mode	Distance	Wavelength (TX)	Wavelength (RX)	Operating Temp.
MFB-FA20	100	WDM(LC)	Single Mode	20km	1310nm	1550nm	0 ~ 60 degrees C
MFB-FB20	100	WDM(LC)	Single Mode	20km	1550nm	1310nm	0 ~ 60 degrees C
MFB-TSA	100	WDM(LC)	Multi Mode	2km	1310nm	1550nm	-40 ~ 75 degrees C
MFB-TSB	100	WDM(LC)	Multi Mode	2km	1550nm	1310nm	-40 ~ 75 degrees C
MFB-TFA20	100	WDM(LC)	Single Mode	20km	1310nm	1550nm	-40 ~ 75 degrees C
MFB-TFB20	100	WDM(LC)	Single Mode	20km	1550nm	1310nm	-40 ~ 75 degrees C
MFB-TFA40	100	WDM(LC)	Single Mode	40km	1310nm	1550nm	-40 ~ 75 degrees C
MFB-TFB40	100	WDM(LC)	Single Mode	40km	1550nm	1310nm	-40 ~ 75 degrees C