

DATASHEET

RJ45 Patch Cord Cat.6A S/FTP TPE Cat.7 raw cable superflex red 2m

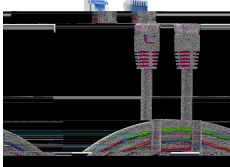
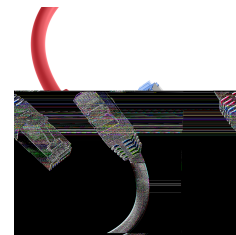
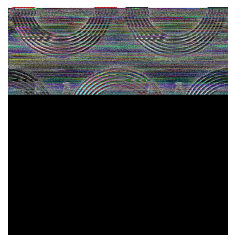
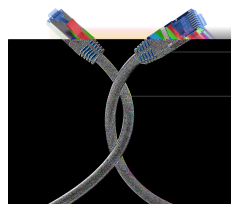
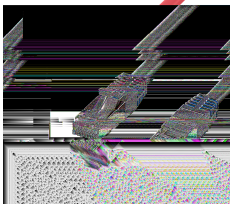
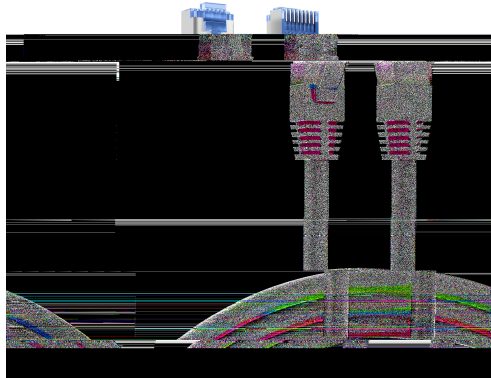

General data

The shielded Cat.6A RJ45 patch cable with **component certification** from the GHMT ensures excellent performance for 10 Gigabit Ethernet applications. The **TPE** outer sheath makes the cable **highly flexible** and thus easier to handle. The moulded grommet captivates with its **slim design** and thus simplifies the insertion process in cramped conditions.

Very flexible TPE/LSZH outer sheath superflex

Cross section 4 x 2 x AWG26 / 7

Moulded grommet, slim design

Length imprint on the boot

Allgemeine Daten

This datasheet was created automatically on 07-05-2024 . Technical changes reserved.



DATASHEET

RJ45 Patch Cord Cat.6A S/FTP TPE Cat.7 raw cable superflex red 2m

Suitable for degree of protection (IP)	IP20
Fire retardant version	True
Model	Shielded
Length imprint	True
Jacket Material	TPE/LSZH
AWG-size	26/7

General data

Connector type	RJ45 Standard blue
Cable type	S/FTP
Pin assignment	1:1
Locking lever	True
Allocation	acc. TIA/EIA 568B
Area of Application	Industrial Ethernet
Colour anti-kink sleeve	red
Colour outer sheath	red
Category	6A (IEC)
Anti-kink sleeve	moulded-on
Contacts	50 µ" gold plated
Halogen free	True

Mechanical characteristics

Conductive shield	360° shield contact
Mating cycles	≥750
Bending radius	>32.5 mm

Cable construction

Raw cable	Cat.7
Conductor Material	Copper

Kabelaufbau

Type of connector connection 2	RJ45 8(8)
Type of connector connection 1	RJ45 8(8)
Cable construction	4x2

This datasheet was created automatically on 07-05-2024 . Technical changes reserved.



DATASHEET

RJ45 Patch Cord Cat.6A S/FTP TPE Cat.7 raw cable superflex red 2m

Cable sheath

Oil resistant (according to EN 60811-404)	False
Silicone-free	True
Low smoke	acc. IEC61034

Kabelmantel

Outer diameter of the cable	6.5 mm
Halogen-free	acc. IEC60754-2
Printing	Cat.6A Patchcord SUPERFLEX S/FTP www.efb-elektronik.de

Environmental conditions

Temperature range	-20 - 75 °C
-------------------	-------------

Electrical characteristics

Resistance unbalance	2 %
Loop resistance	284 Ω/km
Conductor resistance DC	142 Ω/km
NVP value	- %
Contact Resistance	30 mΩ
POE class	PoE+ acc. to IEEE802.3at
Current Rating	max. 1 A
Insulation Resistance	100 MΩ
Impedance	100 ±25 Ω

Elektrische Eigenschaften

Test voltage	1000 V DC, 1min
Operating-/ tempering voltage	max. 50 V DC

Übertragungstechnische Eigenschaften

Transmission	10Gbit
Bandwidth	500MHz

Standards, approvals, certifications

Cabling standard	EN50173
------------------	---------

This datasheet was created automatically on 07-05-2024 . Technical changes reserved.



DATASHEET

RJ45 Patch Cord Cat.6A S/FTP TPE Cat.7 raw cable superflex red 2m

Oil resistant (acc. EN 60811-2-1)	False
Connector	IEC 60603-7-51

Available variants

ArtNr.	Bezeichnung	Length	Längentoleranz
K5525FRT.0,15	RJ45 Patch Cord Cat.6A S/FTP TPE Cat.7 raw cable superflex red 0,15m	0.15 m	±5 %
K5525FRT.0,25	RJ45 Patch Cord Cat.6A S/FTP TPE Cat.7 raw cable superflex red 0,25m	0.25 m	±5 %
K5525FRT.0,5	RJ45 Patch Cord Cat.6A S/FTP TPE Cat.7 raw cable superflex red 0,5m	0.5 m	±5 %
K5525FRT.1	RJ45 Patch Cord Cat.6A S/FTP TPE Cat.7 raw cable superflex red 1m	1.0 m	±5 %
K5525FRT.1,5	RJ45 Patch Cord Cat.6A S/FTP TPE Cat.7 raw cable superflex red 1,5m	1.5 m	±5 %
K5525FRT.2	RJ45 Patch Cord Cat.6A S/FTP TPE Cat.7 raw cable superflex red 2m	2.0 m	±5 %
K5525FRT.3	RJ45 Patch Cord Cat.6A S/FTP TPE Cat.7 raw cable superflex red 3m	3.0 m	±5 %
K5525FRT.5	RJ45 Patch Cord Cat.6A S/FTP TPE Cat.7 raw cable superflex red 5m	5.0 m	±5 %
K5525FRT.7,5	RJ45 Patch Cord Cat.6A S/FTP TPE Cat.7 raw cable superflex red 7,5m	7.5 m	±5 %
K5525FRT.10	RJ45 Patch Cord Cat.6A S/FTP TPE Cat.7 raw cable superflex red 10m	10.0 m	±5 %
K5525FRT.15	RJ45 Patch Cord Cat.6A S/FTP TPE Cat.7 raw cable superflex red 15m	15.0 m	±5 %
K5525FRT.20	RJ45 Patch Cord Cat.6A S/FTP TPE Cat.7 raw cable superflex red 20m	20.0 m	±5 %
K5525FRT.25	RJ45 Patch Cord Cat.6A S/FTP TPE Cat.7 raw cable superflex red 25m	25.0 m	±5 %
K5525FRT.30	RJ45 Patch Cord Cat.6A S/FTP TPE Cat.7 raw cable superflex red 30m	30.0 m	±5 %

Drawings

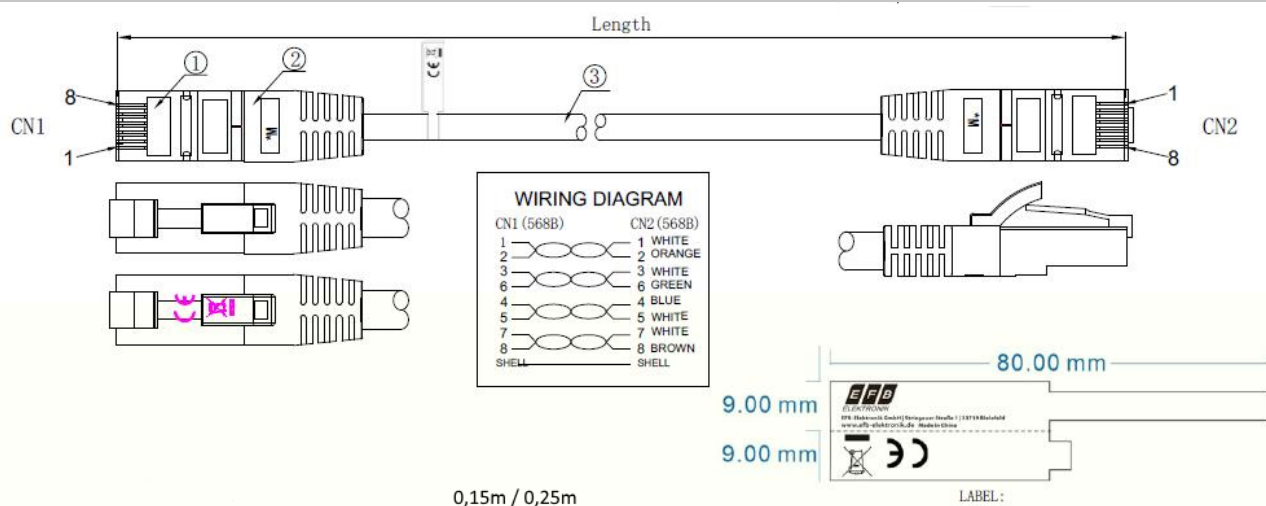

This datasheet was created automatically on 07-05-2024 . Technical changes reserved.

DATASHEET

RJ45 Patch Cord Cat.6A S/FTP TPE Cat.7 raw cable superflex red 2m

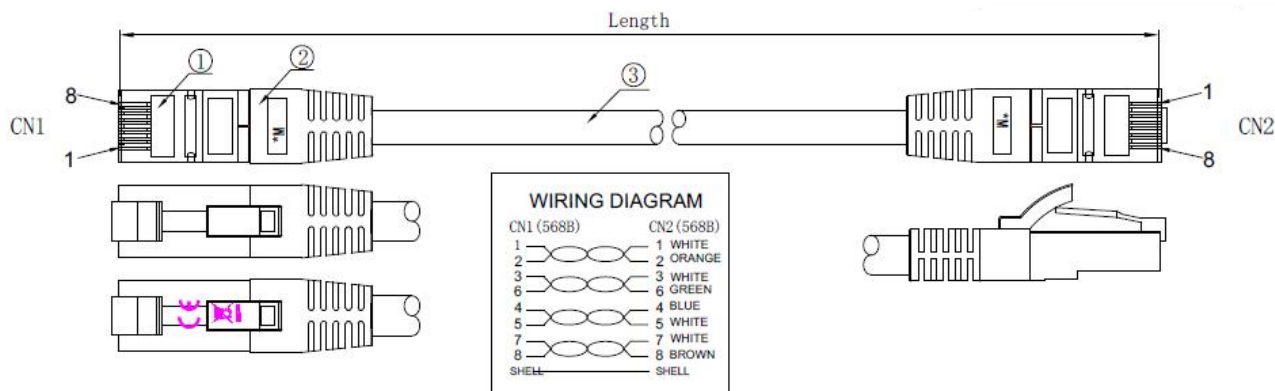

This datasheet was created automatically on 07-05-2024 . Technical changes reserved.

